

Detalle	referencia
Contravidrios2
Corrediza3
Cortina barrio7
Cortina común8
Ventana desplazable9
Paño fijo 40 x 90 mm.10
Paño fijo central11
Paño fijo lateral12
Postigon de rebatir13
Puerta bisagra encolizada15
Puerta A2517
Puerta linea Rosario19
Ventiluz y Banderola22
Puerta de rebatir y vaiven23
Puerta linea Santa Fe25
Puerta tablero tubular27
Puerta placa29
Marco regulable para puerta placa30
Guia cortina31
Tapa cinta32
Acoples33
Premarcos35
Varios36
Vidrio repartido37
Tabiqueria tubular38
Tabique liviano A4239
Techo vidriado40
Mampara de baño41
Baranda balcón43
Parasoles45
Revestimiento y cieloraso47
Frente vidriera49

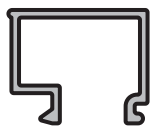

CONTRAVIDRIO UNIVERSAL
PARA MASILLA
Perfil: 38
Peso: 0,156 Kg/m
Matriz: M0715

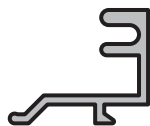

CONTRAVIDRIO 6 mm.
Perfil: 78
Peso: 0,151 Kg/m
Matriz: M1035

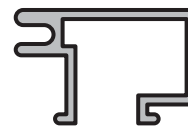

CONTRAVIDRIO 24 mm.
Perfil: 77
Peso: 0,224 Kg/m
Matriz: M1034



CONTRAVIDRIO 14 mm.
Perfil: 79
Peso: 0,189 Kg/m
Matriz: M1108

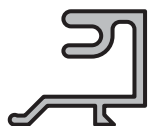

CONTRAVIDRIO 11 mm.
Perfil: 177
Peso: 0,197 Kg/m
Matriz: M2308



CONTRAVIDRIO 17 mm.
Perfil: 80
Peso: 0,197 Kg/m
Matriz: M1109

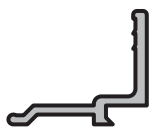

CONTRAVIDRIO
Perfil: 179
Peso: 0,111 Kg/m
Matriz: M2243

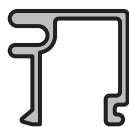

CONTRAVIDRIO
Perfil: 8
Peso: 0,160 Kg/m
Matriz: M0674

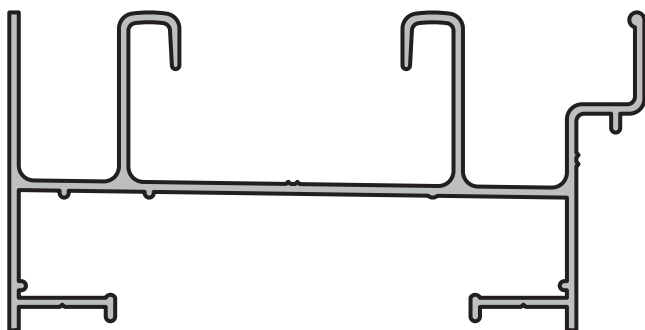

MARCO - VENTANA Y PUERTA CORREDIZA

Perfil: 1

Peso: 0,921 Kg/m

Matriz: MO667

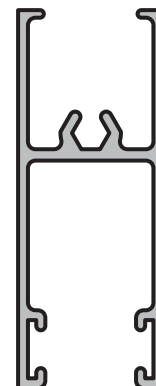

ZOCALO Y CABEZAL - HOJA CORREDIZA

Perfil: 2

Peso: 0,521 Kg/m

Matriz: MO668

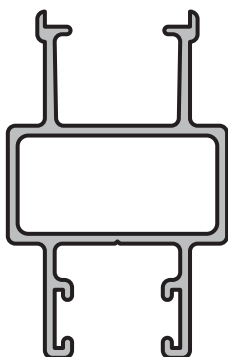

PARANTE LATERAL - HOJA CORREDIZA

Perfil: 3

Peso: 0,577 Kg/m

Matriz: MO669

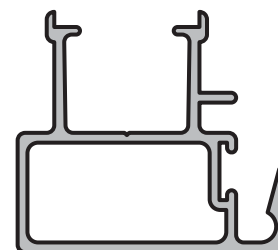

PARANTE CENTRAL - HOJA CORREDIZA

Perfil: 4

Peso: 0,518 Kg/m

Matriz: MO670

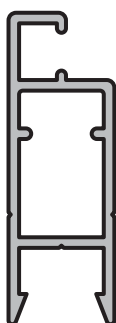

MOSQUITERO

Perfil: 5

Peso: 0,392 Kg/m

Matriz: MO671



TRAVESAÑO - MOSQUITERO

Perfil: 90

Peso: 0,550 Kg/m

Matriz: M1294

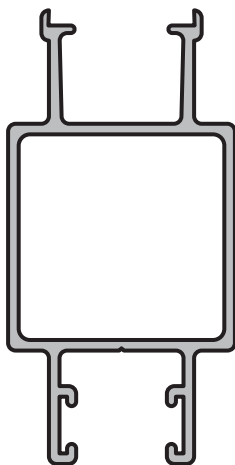

PARANTE LATERAL REFORZADO HOJA
Perfil: 53
Peso: 0,712 Kg/m
Matriz: M0948

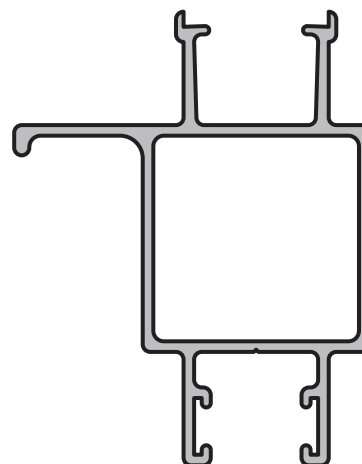

PARANTE LATERAL REFORZADO PUERTA CORREDIZA
Perfil: 220
Peso: 0,821 Kg/m
Matriz: M2673

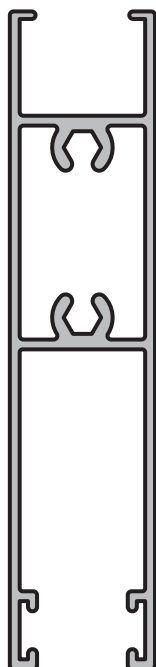

TRAVESAÑO HOJA
PUERTA CORREDIZA
Perfil: 224
Peso: 0,915 Kg/m
Matriz: M2741

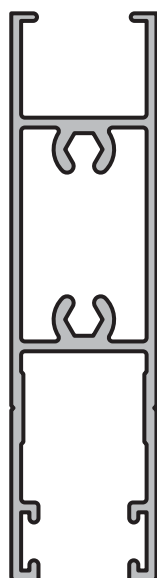

ZOCALO ALTO
PUERTA CORREDIZA
Perfil: 44
Peso: 0,848 Kg/m
Matriz: M0843

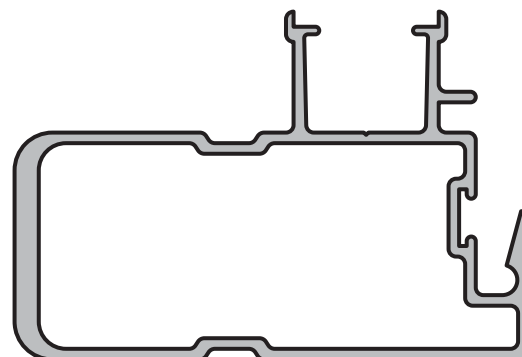

PARANTE CENTRAL REFORZADO - PUERTA CORREDIZA
Perfil: 204
Peso: 1,112 Kg/m
Matriz: M2632

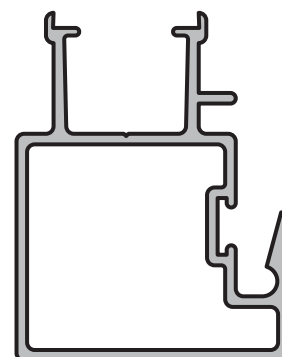

PARANTE CENTRAL REFORZADO HOJA
Perfil: 54
Peso: 0,729 Kg/m
Matriz: M0949

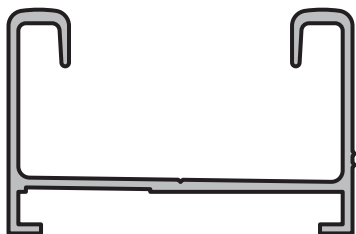

GUIA CON ESCUADRA PARA CORREDIZA

Perfil: 690

Peso: 0,489 Kg/m

Matriz: M1861

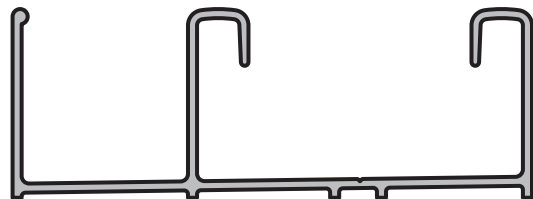

GUIA CORREDIZA CON MOSQUITERO

Perfil: 6568

Peso: 0,540 Kg/m

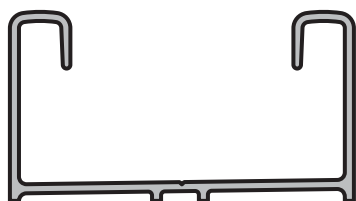

GUIA CORREDIZA SIMPLE

Perfil: 6567

Peso: 0,383 Kg/m

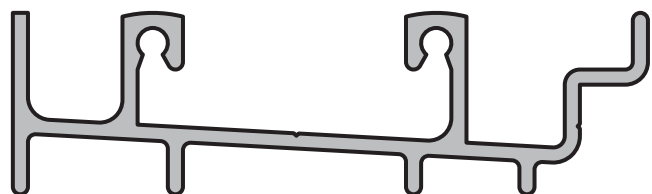

UMBRAL - PUERTA CORREDIZA

Perfil: 17

Peso: 1,050 Kg/m

Matriz: M0688

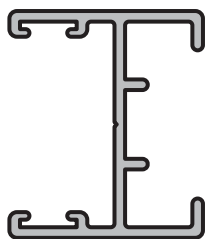

CIERRE CENTRAL - PUERTA Y VENTANA

CORREDIZA 4 HOJAS

Perfil: 19

Peso: 0,389 Kg/m

Matriz: M0686

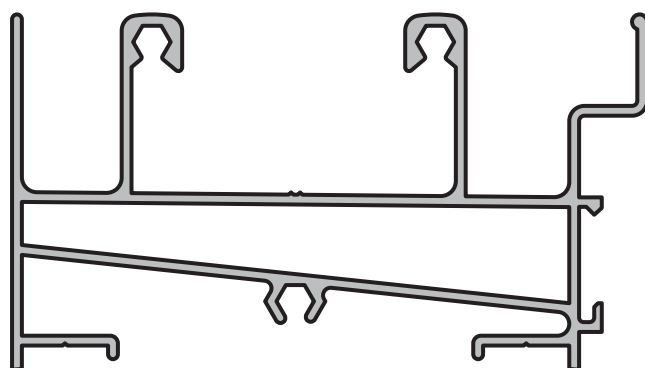

UMBRAL CON CAJA DE AGUA CORREDIZA

Perfil: 219

Peso: 1,369 Kg/m

Matriz: M2677

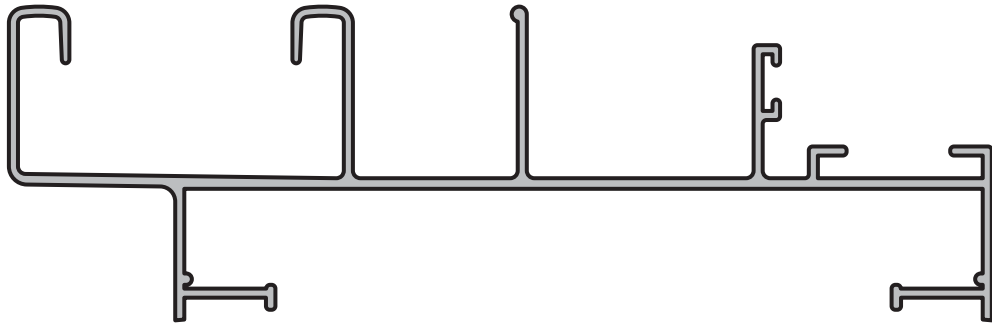

MARCO UNIFICADO CON POSTIGON DE REBATIR

Perfil: 6575

Peso: 1,145 Kg/m

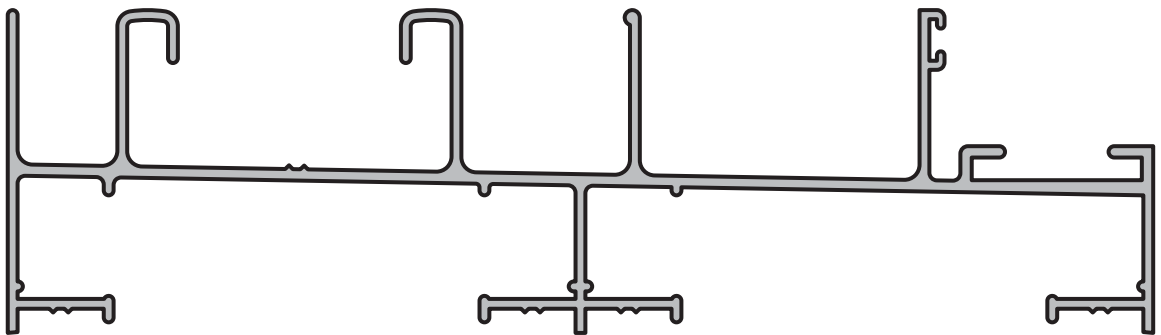

MARCO UNIFICADO CON POSTIGON DE REBATIR

Perfil: 6348

Peso: 1,450 Kg/m

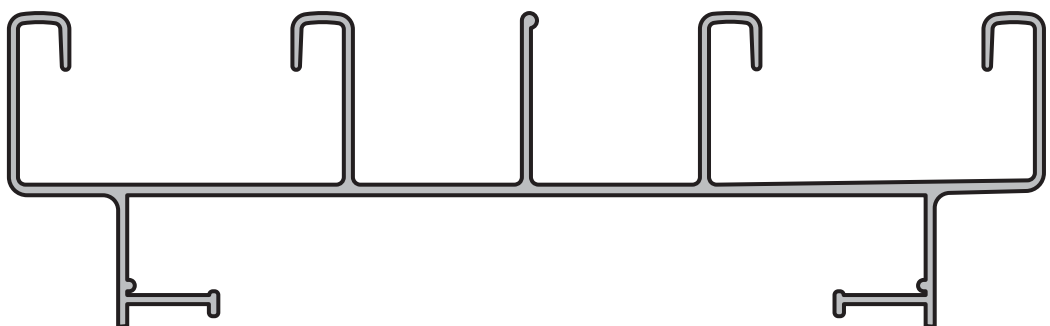

MARCO UNIFICADO CON POSTIGON CORREDIZO

Perfil: 6669

Peso: 1,266 Kg/m

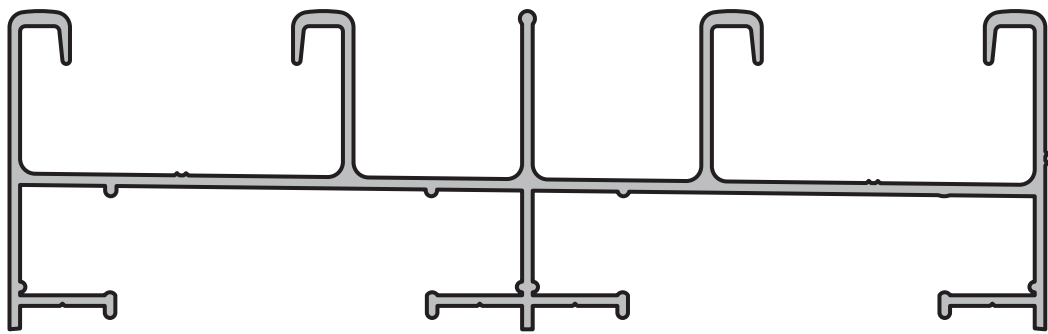

MARCO UNIFICADO CON POSTIGON CORREDIZO

Perfil: 714

Peso: 1,588 Kg/m

Matriz: M2247

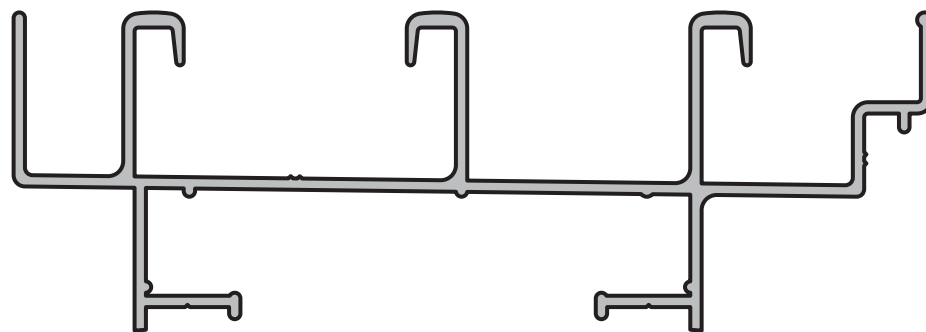

MARCO CORREDIZA DE 3 GUIAS

Perfil: 691

Peso: 1,380 Kg/m

Matriz: M1862

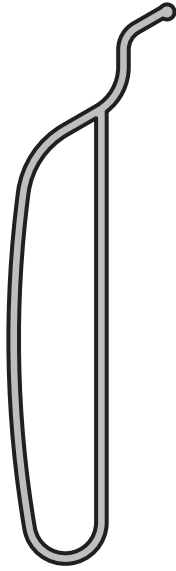

TABLILLA TUBULAR
Perfil: 5423
Peso: 0,545 Kg/m

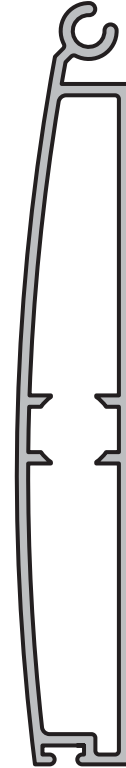

ZOCALO
Perfil: 5550
Peso: 0,958 Kg/m

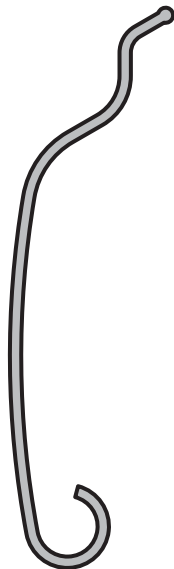

TABLILLA LIVIANA
Perfil: 5425
Peso: 0,400 Kg/m

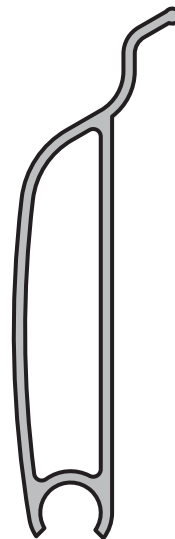

TABLILLA DE COMANDO
Perfil: 5549
Peso: 0,570 Kg/m

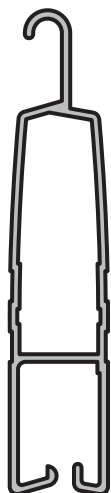

TABLILLA - CORTINA DE ENROLLAR COMUN
Perfil: 5150
Peso: 0,424 Kg/m

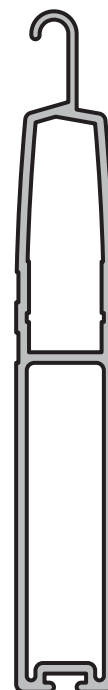

ZOCALO - CORTINA DE ENROLLAR COMUN
PARA PERFIL 5150
Perfil: 5169
Peso: 0,753 Kg/m



TABLILLA CORTINA DE ENROLLAR
Perfil: 6307
Peso: 0,418 Kg/m

ABRIL 2001

10

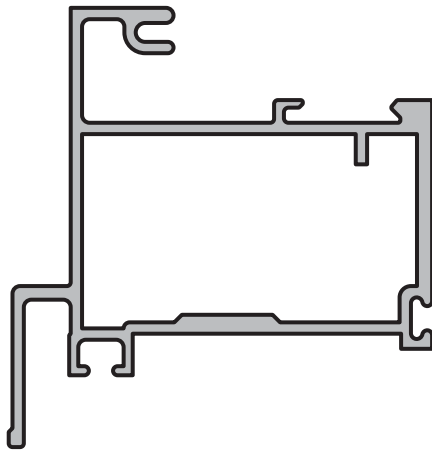

HOJA SIMPLE
Perfil: 140
Peso: 1,064 Kg/m
Matriz: M1901

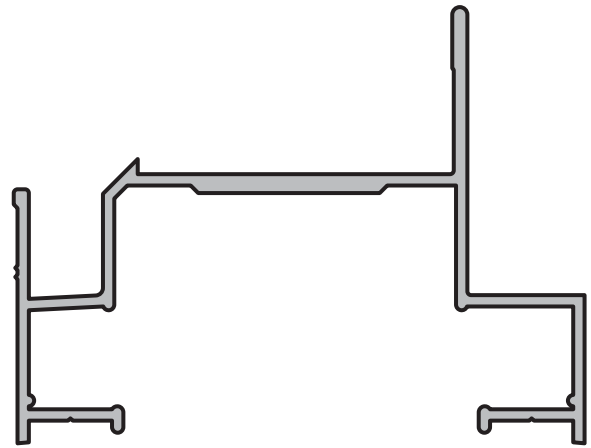

MARCO
Perfil: 139
Peso: 0,937 Kg/m
Matriz: M1900

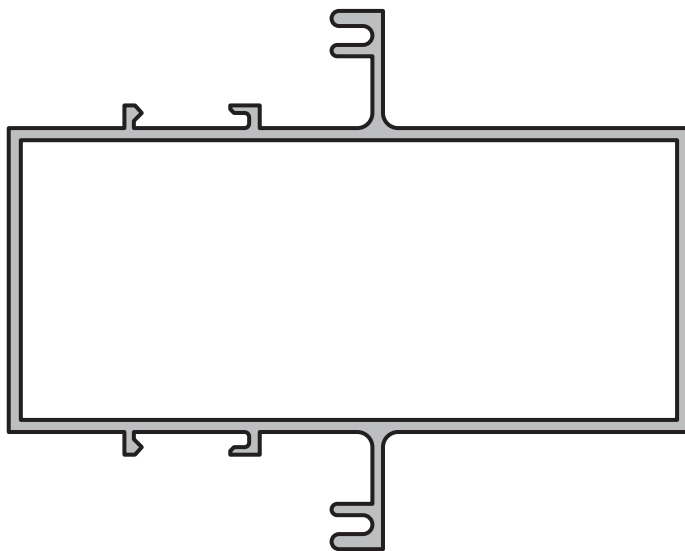

TRAVESAÑO PAÑO FIJO TUBULAR 90 X 40 mm.

Perfil: 700

Peso: 1,372 Kg/m

Matriz: M2146

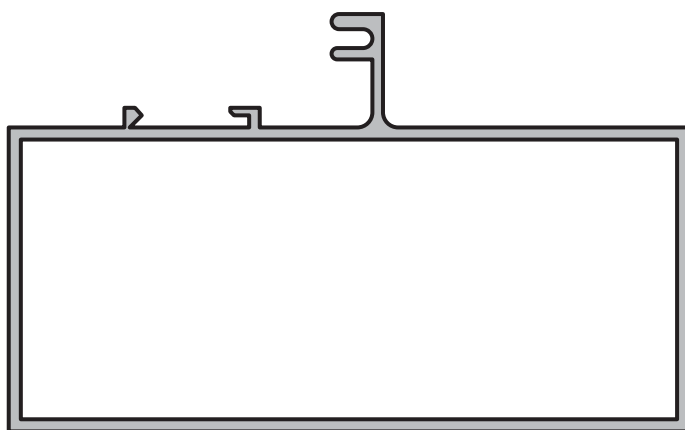

PAÑO FIJO TUBULAR 90 X 40 mm.

Perfil: 711

Peso: 1,237 Kg/m

Matriz: M2147

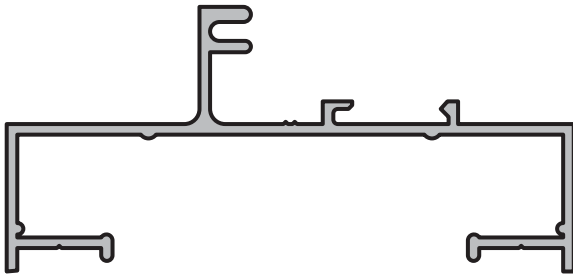

MARCO - PAÑO FIJO Perfil: 7
Peso: 0,683 Kg/m
Matriz: M0673

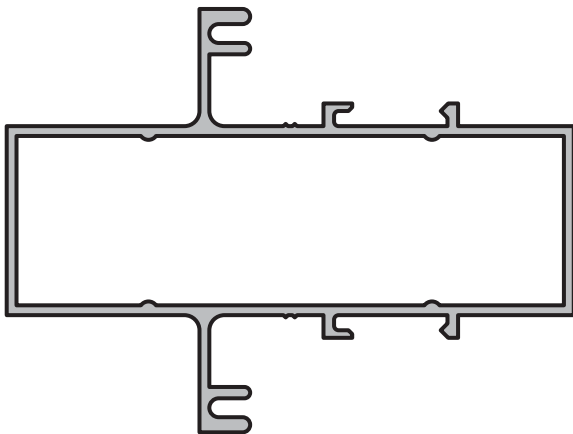

TRAVESAÑO - PAÑO FIJO
Perfil: 94
Peso: 0,975 Kg/m
Matriz: M1366

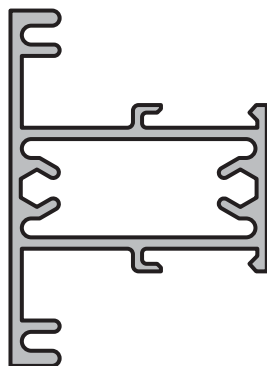

TRAVESAÑO CHICO - PAÑO FIJO
Perfil: 687
Peso: 0,745 Kg/m
Matriz: M1777

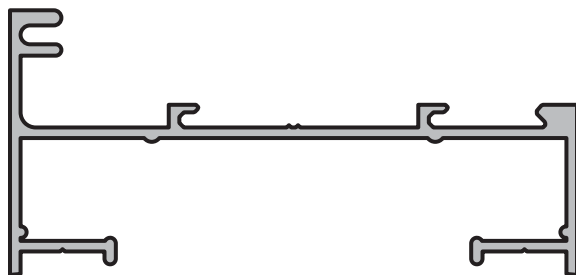
**MARCO - PAÑO FIJO (3 a 57 mm.)**

Perfil: 162

Peso: 0,718 Kg/m

Matriz: M2104

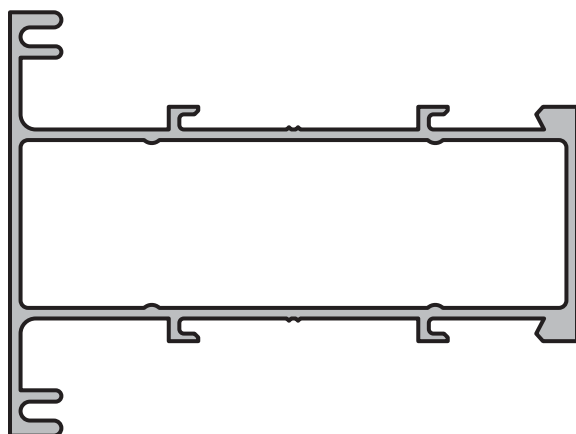
**TRAVESAÑO - PAÑO FIJO (3 a 57 mm.)**

Perfil: 183

Peso: 1,094 Kg/m

Matriz: M2383

**CONTRAVIDRIO DOBLE**

Perfil: 184

Peso: 0,354 Kg/m

Matriz: M2384

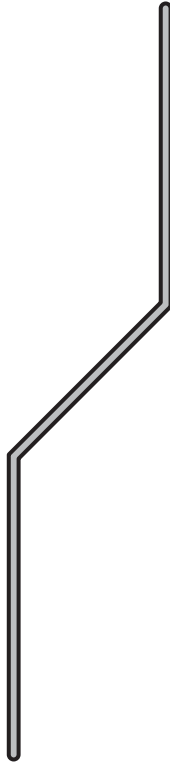

TABLILLA POSTIGON 100 mm.
Perfil: 127
Peso: 0,375 Kg/m
Matriz: M1754

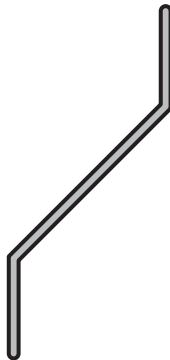

TABLILLA POSTIGON DE 46,6 mm.
Perfil: 153
Peso: 0,186 Kg/m
Matriz: M2009

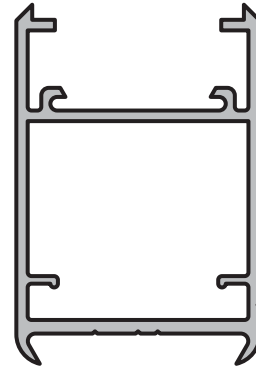

BATIENTE DE HOJA
Perfil: 174
Peso: 0,713 Kg/m
Matriz: M2260



DISTANCIADOR DE TABLILLA
Perfil: 126
Peso: 0,138 Kg/m
Matriz: M1760

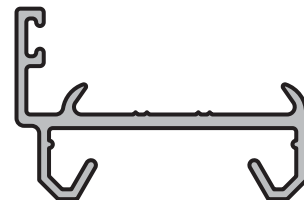

MARCO ANGOSTO - PUERTA CON BISAGRA
ENCOLIZADA /POSTIGON
Perfil: 508
Peso: 0,394 Kg/m
Matriz: M1542

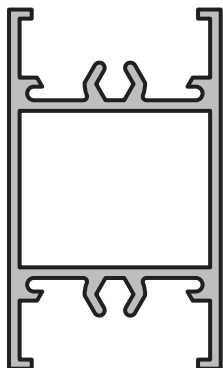

TRAVESAÑO DE HOJA

Perfil: 173

Peso: 0,710 Kg/m

Matriz: M2259

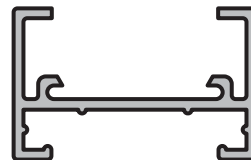

SOPORTE TABLILLA DE POSTIGON

Perfil: 148

Peso: 0,340 Kg/m

Matriz: M1986

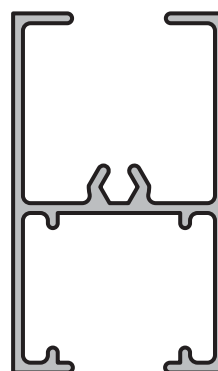

TRAVESAÑO POSTIGON DE ABRIR PARA 5800

Perfil: 226

Peso: 0,591 Kg/m

Matriz: M2806

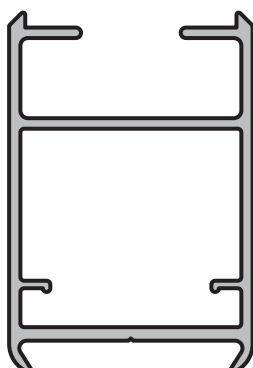

PARANTE POSTIGON DE ABRIR PARA 5800

Perfil: 227

Peso: 0,712 Kg/m

Matriz: M2805

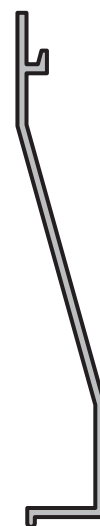

TABLILLA POSTIGON

Perfil: 5800

Peso: 0,270 Kg/m

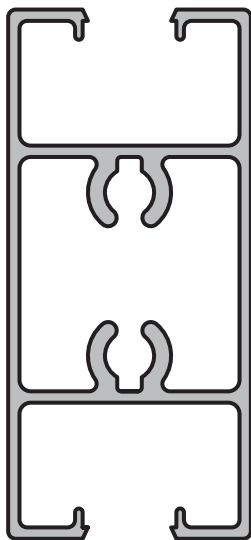
TRAVESAÑO DE HOJA

Perfil: 510
 Peso: 1,246 Kg/m
 Matriz: M1545

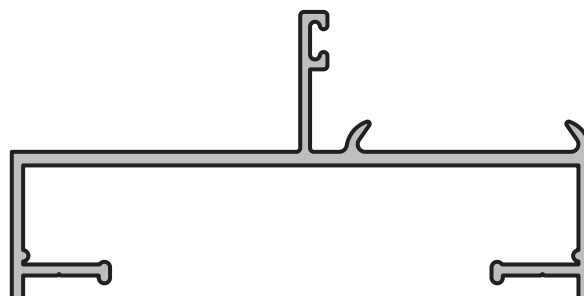
MARCO

Perfil: 524
 Peso: 0,745 Kg/m
 Matriz: M2333

CONTRAVIDRIO INTERNO

Perfil: 507
 Peso: 0,108 Kg/m
 Matriz: M1540

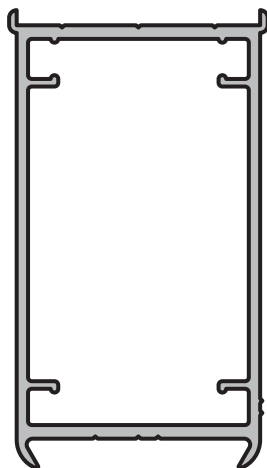
BATIENTE DE HOJA

Perfil: 509
 Peso: 0,821 Kg/m
 Matriz: M1544

TRAVESAÑO INTERMEDIO

Perfil: 527
 Peso: 0,586 Kg/m
 Matriz: M2348

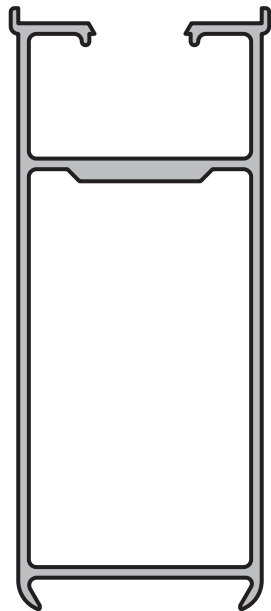

BATIENTE SIN CONTRAVIDRIOS
Perfil: 6350
Peso: 0,977 Kg/m



TAPACANTO
Perfil: 511
Peso: 0,124 Kg/m
Matriz: M1546

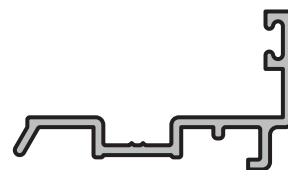

TAPACANTO CON TOPE
Perfil: 519
Peso: 0,262 Kg/m
Matriz: M1909



CONTRAVIDRIO EXTERNO
Perfil: 526
Peso: 0,140 Kg/m
Matriz: M2336

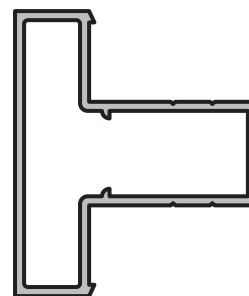

TRAVESAÑO ANGOSTO
Perfil: 528
Peso: 0,443 Kg/m
Matriz: M2530

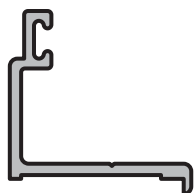

MARCO HOJA SECUNDARIA
Perfil: 525
Peso: 0,213 Kg/m
Matriz: M2335

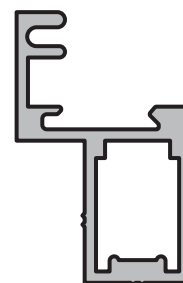

HOJA SECUNDARIA PUERTA
Perfil: 136
Peso: 0,497 Kg/m
Matriz: M1876

ABRIL 2001

18

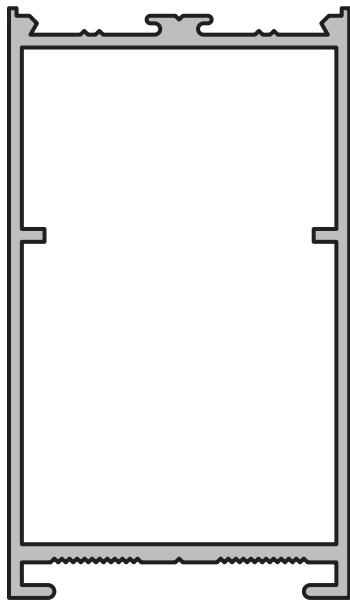

HOJA
Perfil: 5616
Peso: 1,288 Kg/m



CONTRAVIDRIO 8 mm.
Perfil: 5596
Peso: 0,140 Kg/m

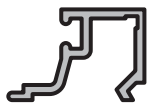

CONTRAVIDRIO 12 mm.
Perfil: 5588
Peso: 0,146 Kg/m



TAPAJUNTA
Perfil: 5707
Peso: 0,232 Kg/m

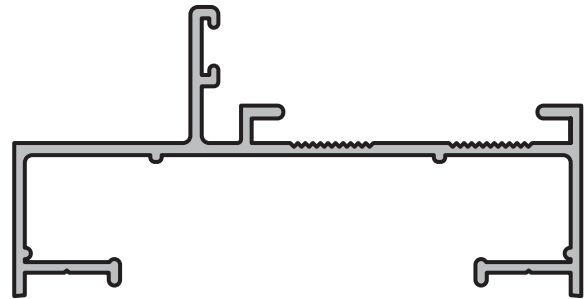

MARCO
Perfil: 5362
Peso: 0,745 Kg/m

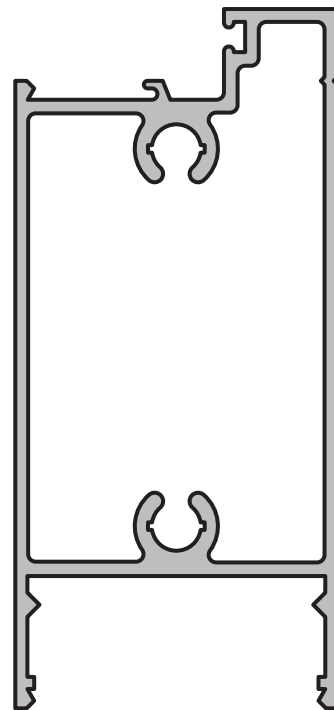

ZOCALO
Perfil: 5624
Peso: 1,569 Kg/m

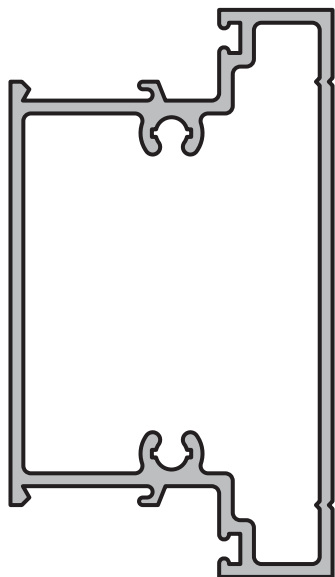

TRAVESAÑO
Perfil: 5617
Peso: 1,277 Kg/m

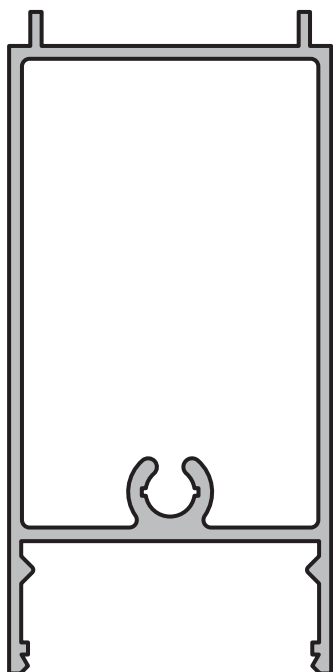

COMPLEMENTO ZOCALO
Perfil: 5623
Peso: 1,293 Kg/m

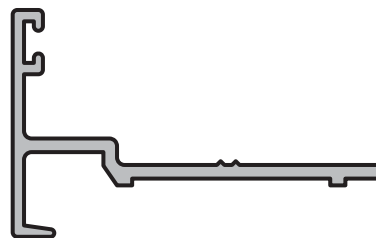

DOBLE CONTACTO
Perfil: 5622
Peso: 0,418 Kg/m



TAPAJUNTA BATIENTE
Perfil: 5621
Peso: 0,248 Kg/m

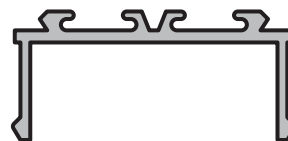

PORTACONTRAVIDRIO/
PORTAFELPA
Perfil: 5628
Peso: 0,289 Kg/m

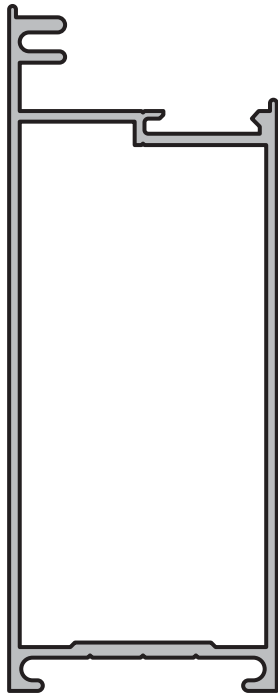

PARANTE ANCHO
Perfil: M-2499
Peso: 1,015 Kg/m
Matriz: M2499

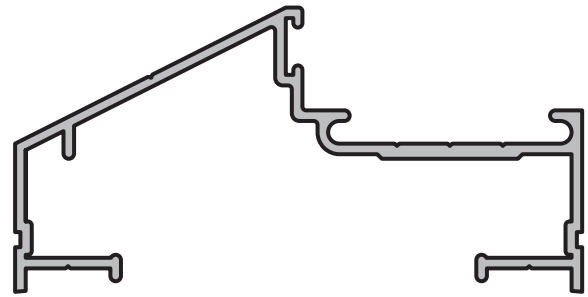

MARCO
Perfil: M-2473
Peso: 0,724 Kg/m
Matriz: M2473

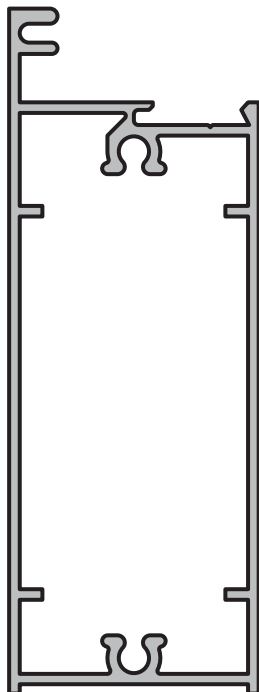

ZOCALO Y CABEZAL ANCHO
Perfil: M-2213
Peso: 1,107 Kg/m
Matriz: M2213

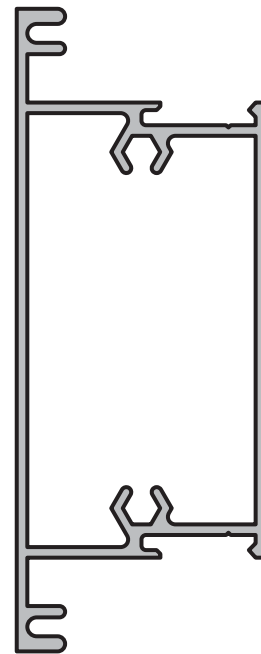

TRAVESANO ANCHO
Perfil: M-2212
Peso: 1,010 Kg/m
Matriz: M2212

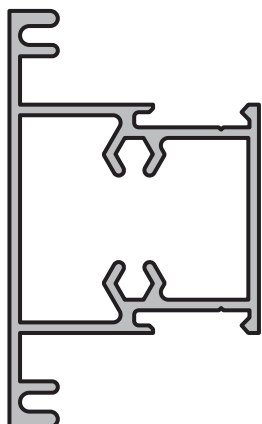
**TRAVESAÑO ANGOSTO**

Perfil: M-2211

Peso: 0,783 Kg/m

Matriz: M2211

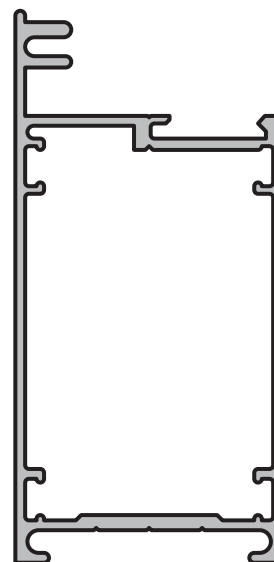
**PARANTE MEDIANO**

Perfil: M-2666

Peso: 0,907 Kg/m

Matriz: M2666

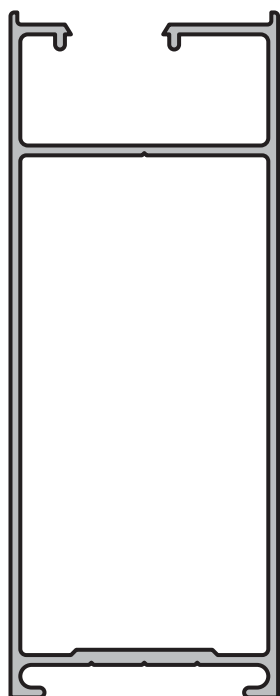
**BATIENTE SIN CONTRAVIDRIO**

Perfil: M-2894

Peso: 1,007 Kg/m

Matriz: M2894

**DOBLE CONTACTO**

Perfil: M-2471

Peso: 0,200 Kg/m

Matriz: M2471

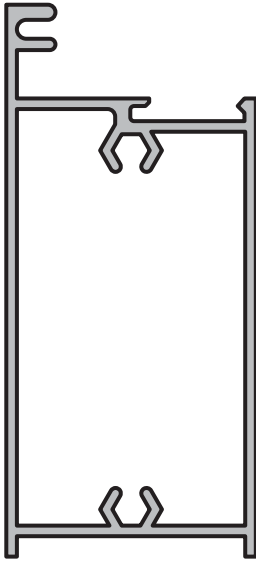

ZOCALO MEDIANO
Perfil: M-2809
Peso: 0,896 Kg/m
Matriz: M2809

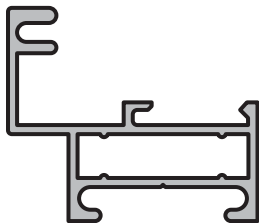

POSTIGO
Perfil: M-2562
Peso: 0,419 Kg/m
Matriz: M2562

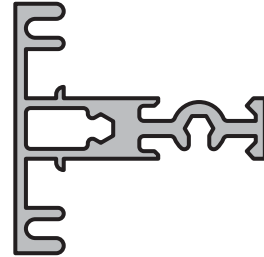

TRAVESANO VIDRIO REPARTIDO
Perfil: M-2665
Peso: 0,562 Kg/m
Matriz: M2665

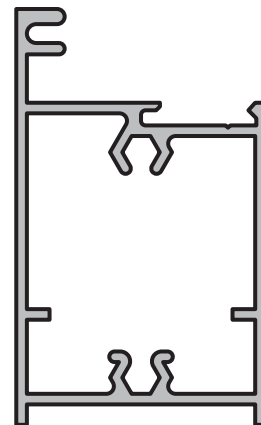

ZOCALO Y CABEZAL ANGOSTO
Perfil: M-2217
Peso: 0,799 Kg/m
Matriz: M2217

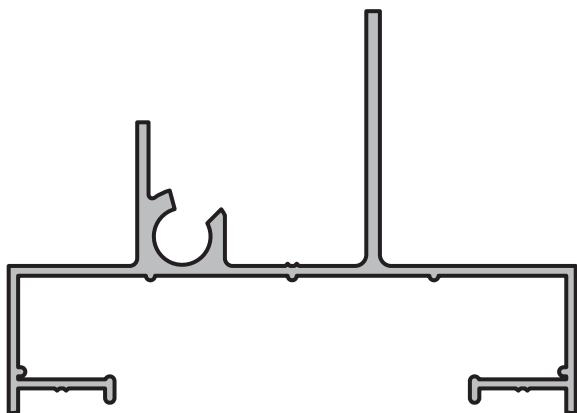

MARCO
Perfil: 216
Peso: 0,826 Kg/m
Matriz: M2705

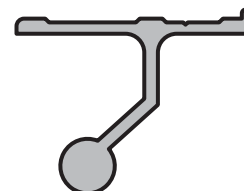

BISAGRA
Perfil: 215
Peso: 0,338 Kg/m
Matriz: M2704

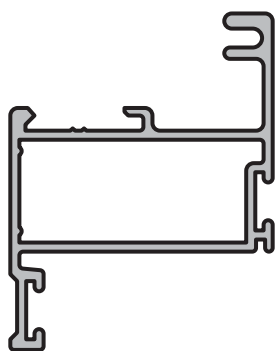

HOJA BANDEROLA
Perfil: 217
Peso: 0,548 Kg/m
Matriz: M2706

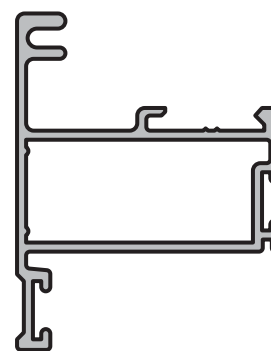

HOJA VENTILUZ
Perfil: 218
Peso: 0,548 Kg/m
Matriz: M2707

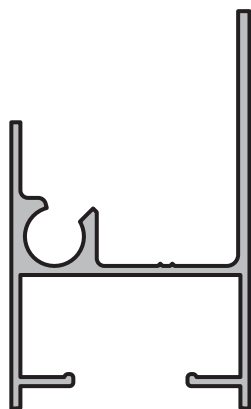

MARCO 31,5 mm.
Perfil: 6565
Peso: 0,556 Kg/m
Matriz: P6565

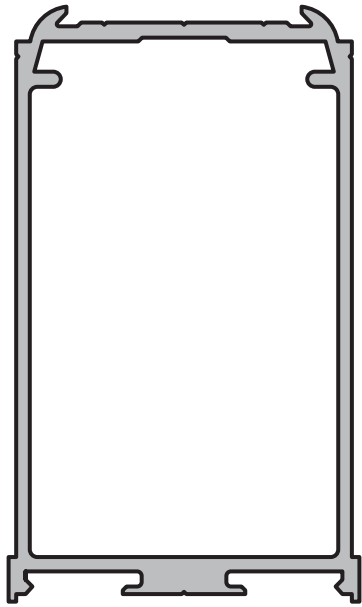

PARANTE HOJA
Perfil: 39
Peso: 1,364 Kg/m
Matriz: M0796

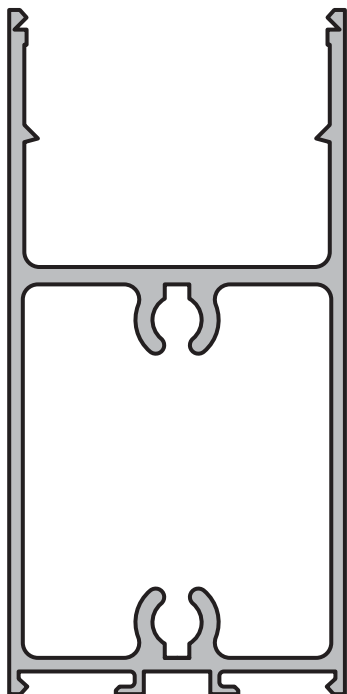

TRAVESAÑO HOJA
Perfil: 11
Peso: 1,671 Kg/m
Matriz: M0677

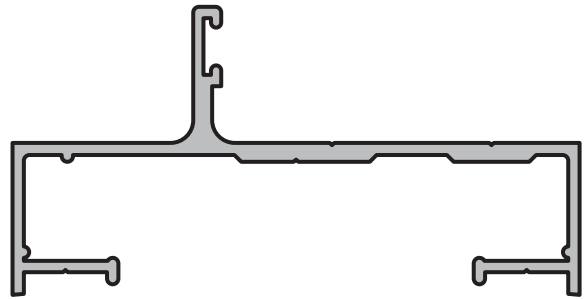

MARCO
Perfil: 10
Peso: 0,788 Kg/m
Matriz: M0676

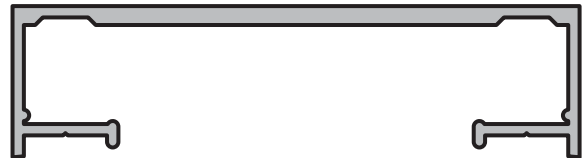

MARCO - PUERTA VAIVEN
Perfil: 24
Peso: 0,730 Kg/m
Matriz: M0693



TAPACANTO
Perfil: 41
Peso: 0,232 Kg/m
Matriz: M0798

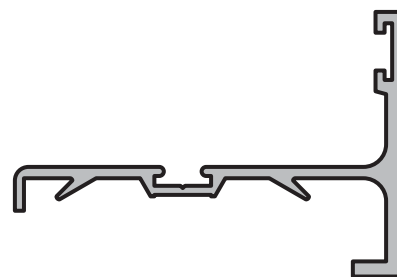

TAPACANTO CON TOPE PARA BATIENTE
Perfil: 42
Peso: 0,481 Kg/m
Matriz: M0799

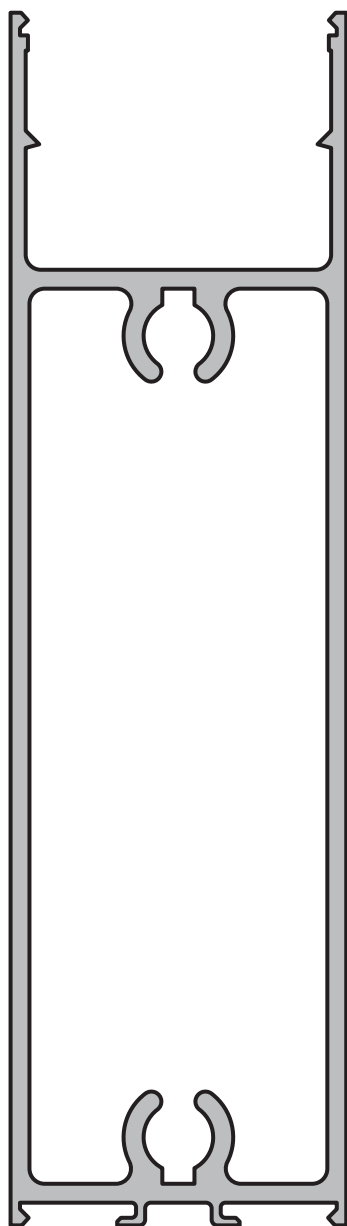

TRAVESAÑO REFORZADO HOJA
Perfil: 65
Peso: 3,059 Kg/m
Matriz: M0954



TAPACANTO - PUERTA VAIVEN
Perfil: 40
Peso: 0,140 Kg/m
Matriz: M0797

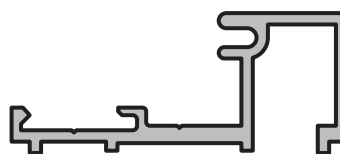

PORTA CONTRAVIDRIOS
Perfil: 43
Peso: 0,429 Kg/m
Matriz: M0844

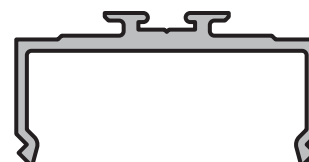

PORTA BURLETE Y PORTA CONTRAVIDRIO
Perfil: 23
Peso: 0,394 Kg/m
Matriz: M0692

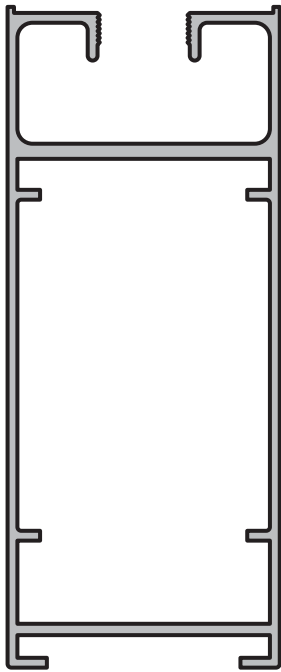

PARANTE
Perfil: 3938
Peso: 1,120 Kg/m

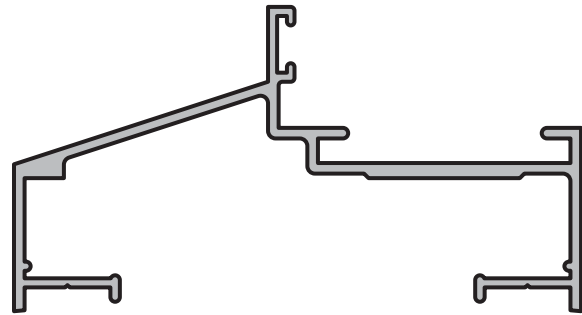

MARCO
Perfil: 3939
Peso: 0,715 Kg/m

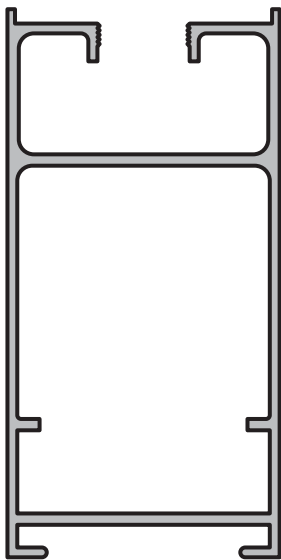

PARANTE MEDIANO
Perfil: 3792
Peso: 0,961 Kg/m

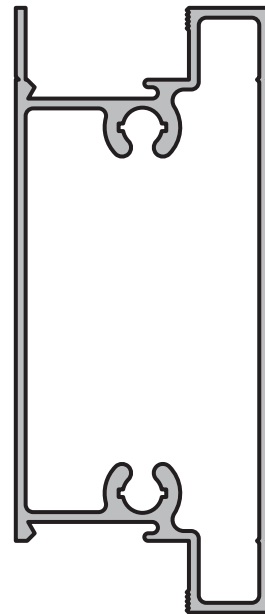

TRAVESAÑO/ ZOCALO/ CABEZAL HOJA
Perfil: 3941
Peso: 1,039 Kg/m

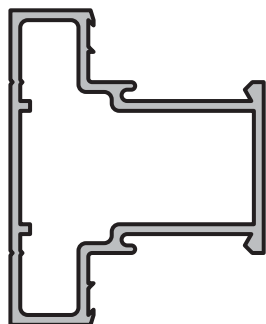

TRAVESAÑO CHICO

Perfil: 3937

Peso: 0,505 Kg/m

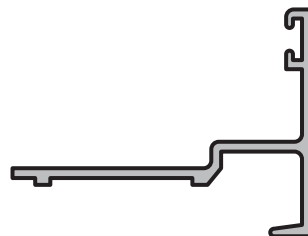

DOBLE CONTACTO

Perfil: 3940

Peso: 0,284 Kg/m

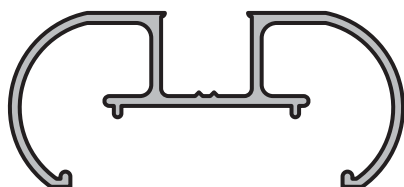

PORTA PLACA REDONDO

Perfil: 6486

Peso: 0,467 Kg/m

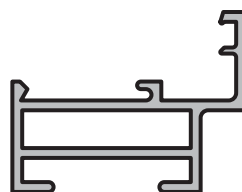

HOJA POSTIGO

Perfil: 6335

Peso: 0,370 Kg/m

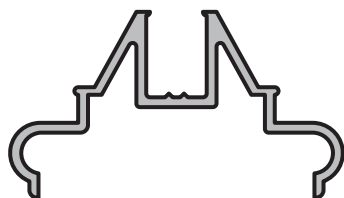

PORTA PLACA RECTO

Perfil: 6487

Peso: 0,367 Kg/m

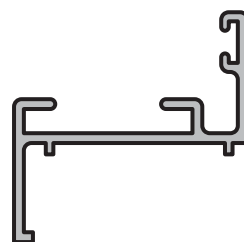

MARCO POSTIGO

Perfil: 6336

Peso: 0,300 Kg/m

ABRIL 2001

28

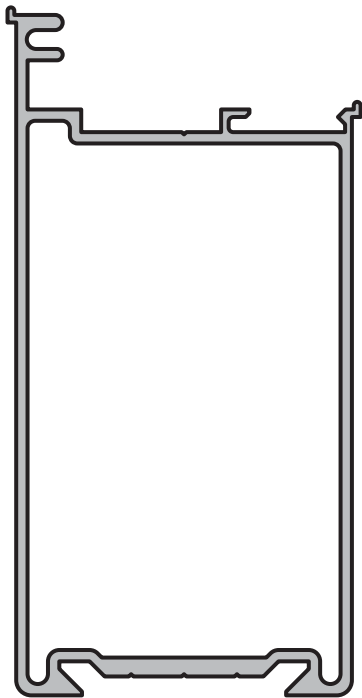

BATIANTE DE HOJA
Perfil: 213
Peso: 1,226 Kg/m
Matriz: M2701

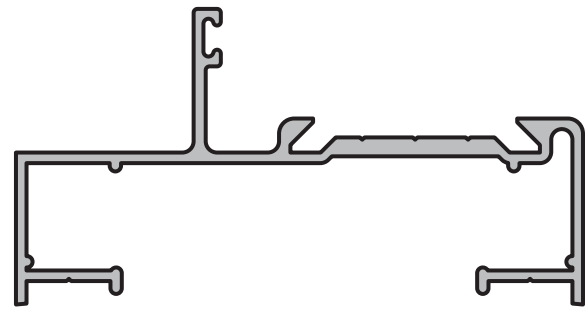

MARCO
Perfil: 211
Peso: 0,780 Kg/m
Matriz: M2699

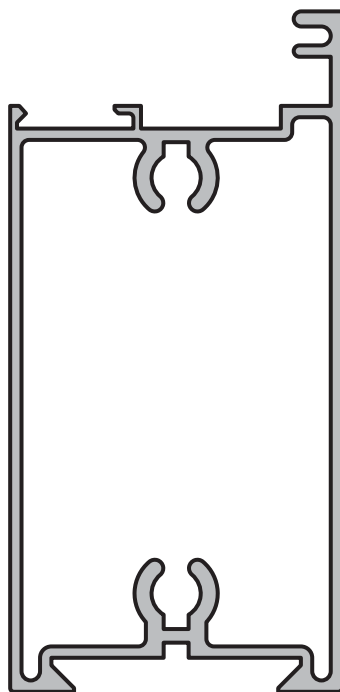

TRAVESAÑO SUPERIOR E INFERIOR
Perfil: 212
Peso: 1,436 Kg/m
Matriz: M2700

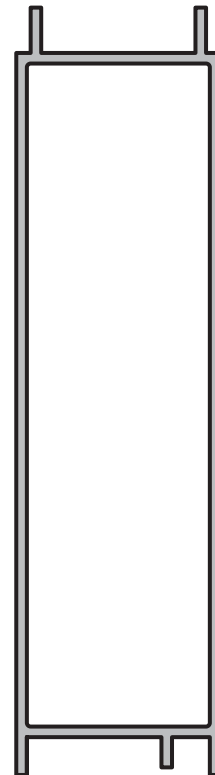

TABLILLA
Perfil: 207
Peso: 0,967 Kg/m
Matriz: M2695

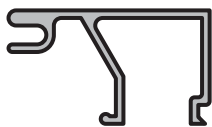

CONTRAVIDRIO
Perfil: 205
Peso: 0,199 Kg/m
Matriz: M2693

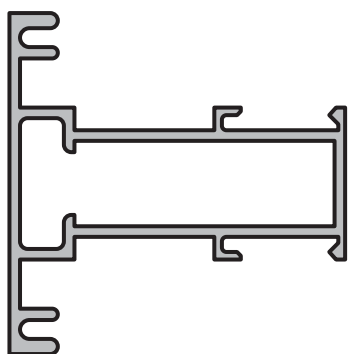

TRAVESAÑO PARA VIDRIO PARTIDO
Perfil: 209
Peso: 0,718 Kg/m
Matriz: M2697



CONTRAVIDRIO
Perfil: 206
Peso: 0,119 Kg/m
Matriz: M2694

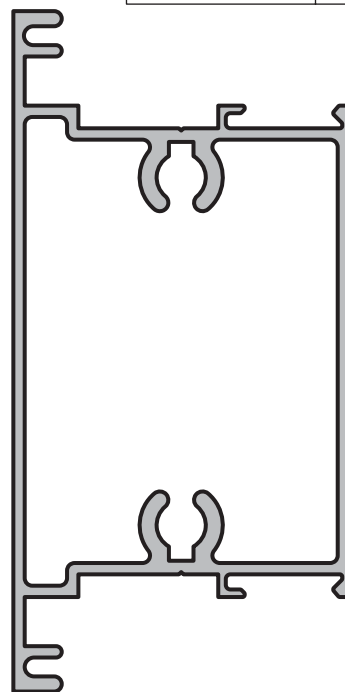

TRAVESAÑO INTERMEDIO
Perfil: 208
Peso: 1,369 Kg/m
Matriz: M2696

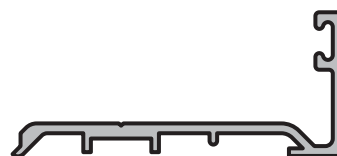

TAPACANTO CENTRAL HOJA
Perfil: 214
Peso: 0,275 Kg/m
Matriz: M2702

ABRIL 2001

30

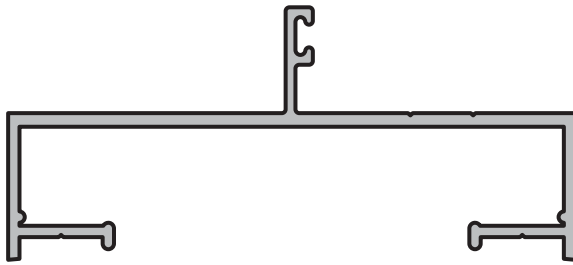

MARCO - PUERTA PLACA SIMPLE CONTACTO

Perfil: 681

Peso: 0,699 Kg/m

Matriz: M1724

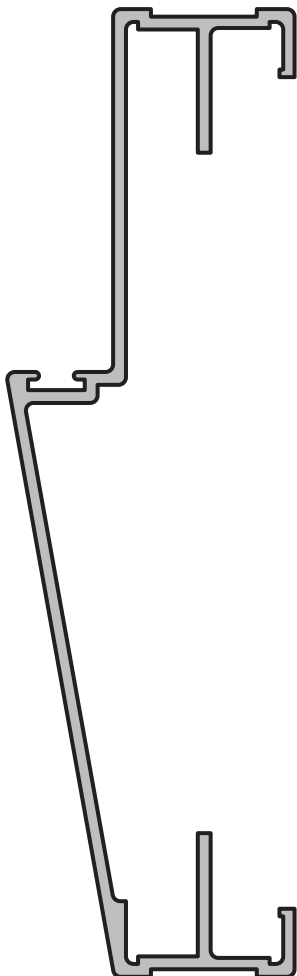

MARCO PUERTA PLACA PARA PARED 100 mm.

Perfil: 4328

Peso: 1,080 Kg/m

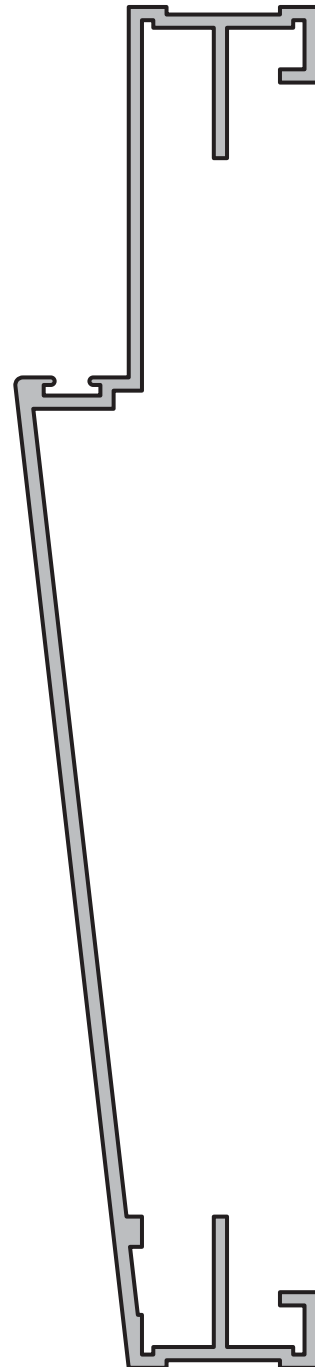

MARCO PUERTA PLACA PARA PARED 150 mm.

Perfil: 4329

Peso: 1,568 Kg/m

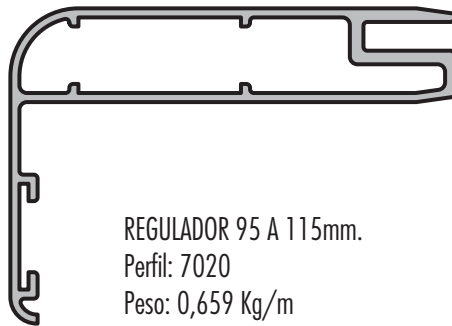

REGULADOR 95 A 115mm.
Perfil: 7020
Peso: 0,659 Kg/m



REGULADOR 115 A 135mm.
Perfil: 7021
Peso: 0,791 Kg/m

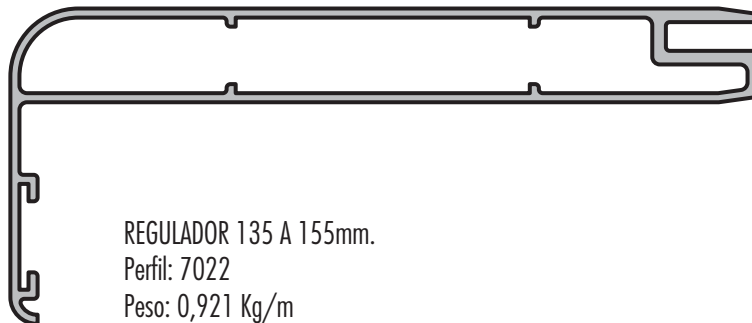

REGULADOR 135 A 155mm.
Perfil: 7022
Peso: 0,921 Kg/m

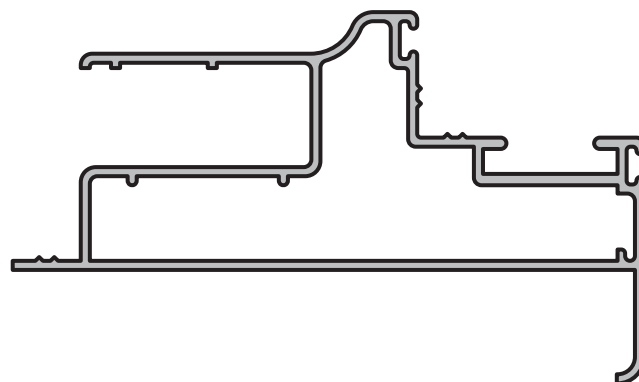

MARCO PUERTA PLACA
Perfil: 7023
Peso: 0,956 Kg/m

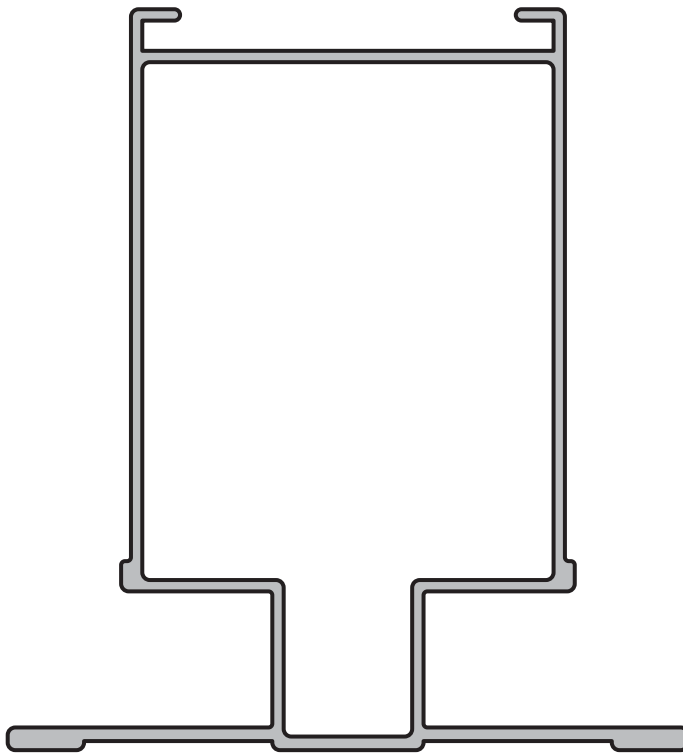

GUÍA CENTRAL - CORTINA BARRIOS
Perfil: 131
Peso: 1,723 Kg/m
Matriz: M1852

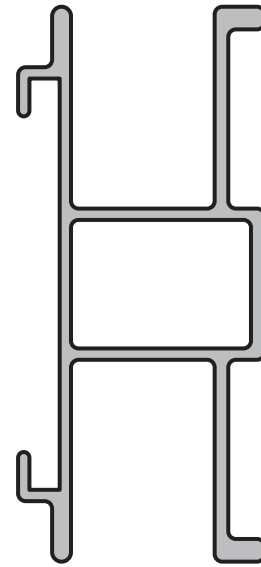

GUÍA CENTRAL - CORTINA COMUN
Perfil: 130
Peso: 1,053 Kg/m
Matriz: M1851

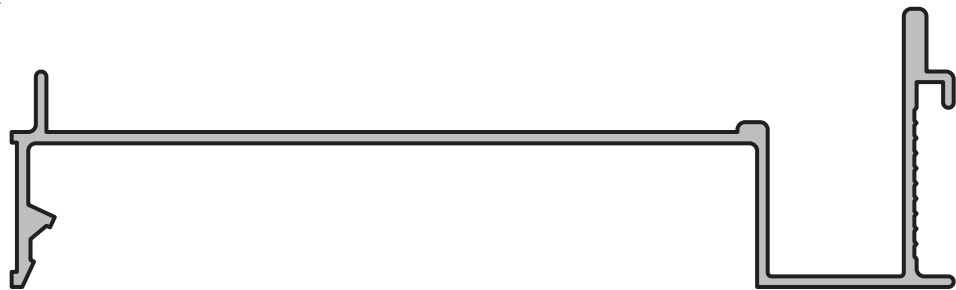

GUÍA DE CORTINA BARRIOS
Perfil: 21
Peso: 0,926 Kg/m
Matriz: M0690

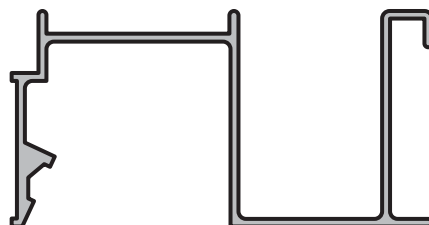

GUÍA CORTINA DE ENROLLAR
Perfil: 920
Peso: 0,456 Kg/m
Matriz: M2355

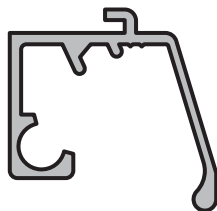
**BISAGRA TAPACINTA**

Perfil: 128

Peso: 0,343 Kg/m

Matriz: M1847

**TAPACINTA**

Perfil: 129

Peso: 0,589 Kg/m

Matriz: M1848

**TAPACINTA**

Perfil: 521

Peso: 0,427 Kg/m

Matriz: M1985

**COMPLEMENTO TAPACINTA**

Perfil: 715

Peso: 0,516 Kg/m

Matriz: M2408

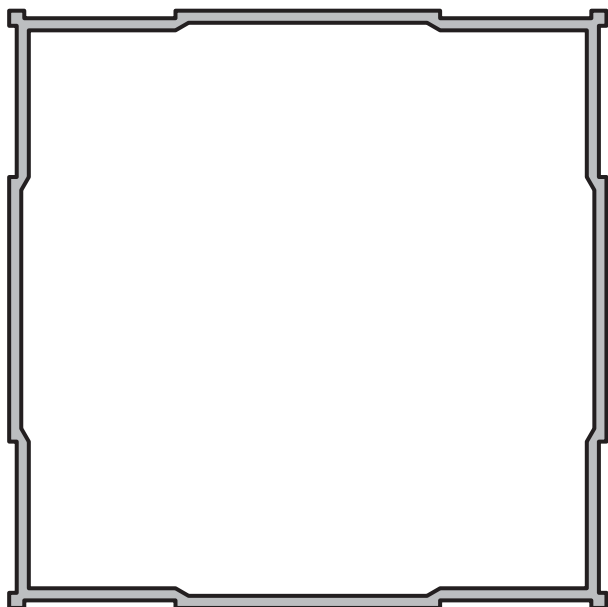
**COLUMNA DE ACOPLÉ**

Perfil: 185

Peso: 1,350 Kg/m

Matriz: M2450

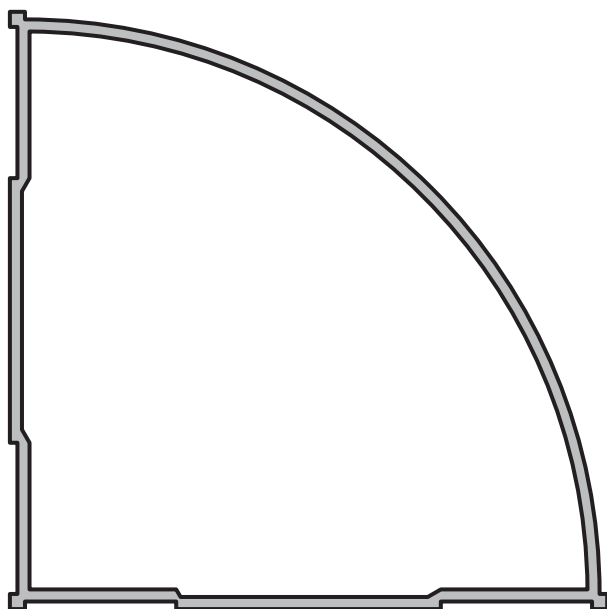
**ACOPLÉ EN ESQUINA**

Perfil: 186

Peso: 1,202 Kg/m

Matriz: M2457

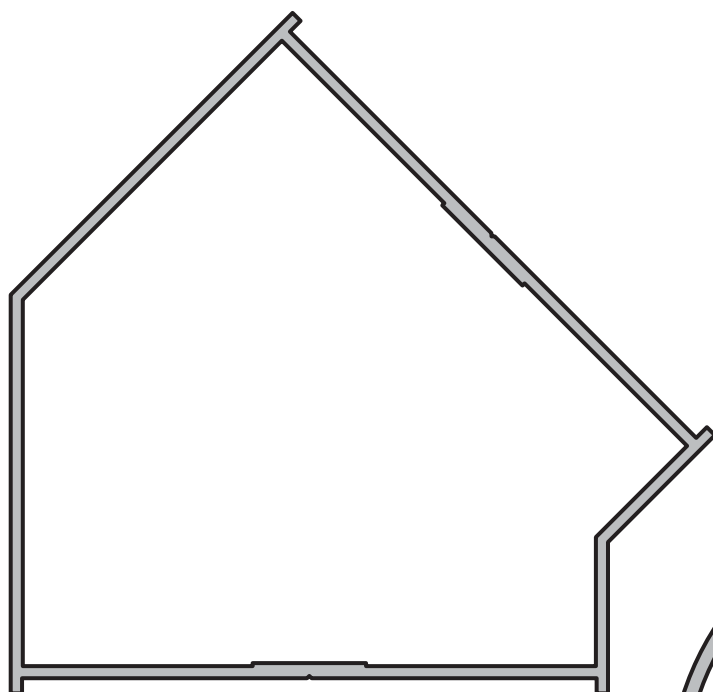

TUBO DE ACOPLE A 45

Perfil: 718

Peso: 1,320 Kg/m

Matriz: M2506

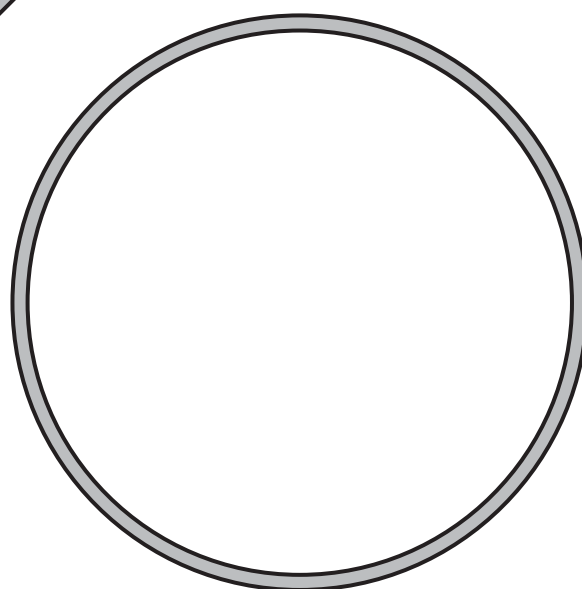

TUBO DIAMETRO 76x2 PARA ROTULA

Perfil: PC744

Peso: 1,240 Kg/m



PERFIL DE ACOPLE 75 mm

Perfil: 6569

Peso: 0,416 Kg/m

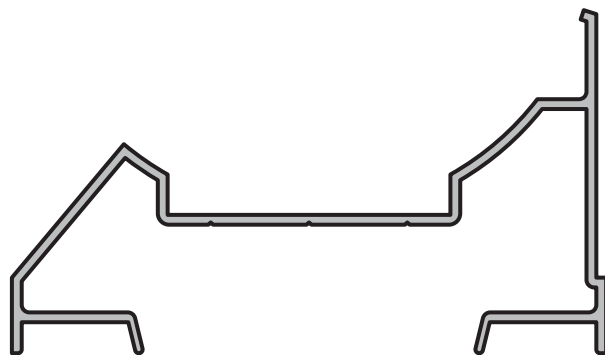

PERFIL ROTULA

Perfil: 187

Peso: 0,678 Kg/m

Matriz: M2461

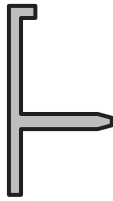

TAPA PARA PREMARCO UNIVERSAL

Perfil: 2501

Peso: 0,173 Kg/m

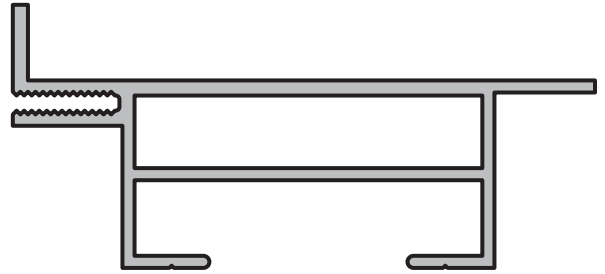

PREMARCO UNIVERSAL

Perfil: 2500

Peso: 0,988 Kg/m

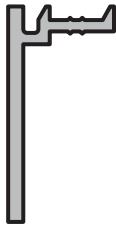

TAPAJUNTA

Perfil: 46

Peso: 0,224 Kg/m

Matriz: M0872

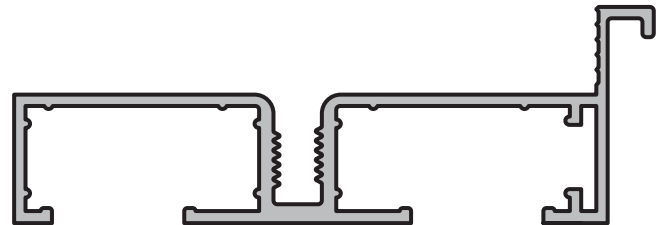

PREMARCO STANDARD

Perfil: 51

Peso: 0,883 Kg/m

Matriz: M0946

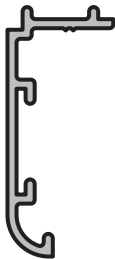

TAPAJUNTA CURVO

Perfil: 7149

Peso: 0,194 Kg/m



PREMARCO 80 mm

Perfil: 6901

Peso: 0,710 Kg/m



TAPAJUNTA JOTA

Perfil: M-0124

Peso: 0,172 Kg/m

Matriz: M0124

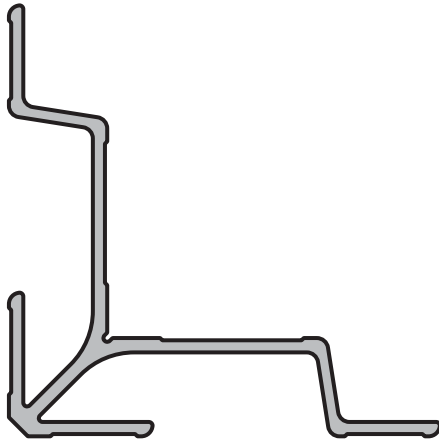

ESCUADRA DE ARMADO PARTE A B y C

Perfil: 37

Peso: 0,745 Kg/m

Matriz: M0642



MOSQUITERO CHICO

Perfil: 6

Peso: 0,199 Kg/m

Matriz: M0197

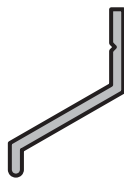

BOTA AGUA

Perfil: 5746

Peso: 0.124 Kg/m

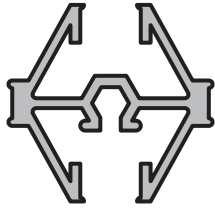
**TRAVESAÑO VIDRIO REPARTIDO**

Perfil: 801

Peso: 0,434 Kg/m

Matriz: M2775

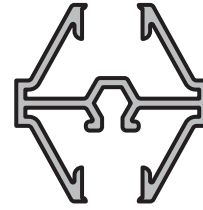
**TRAVESAÑO VIDRIO REPARTIDO**

Perfil: 6571

Peso: 0,359 Kg/m

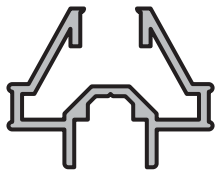
**BASTIDOR VIDRIO REPARTIDO CORREDIZA**

Perfil: 800

Peso: 0,305 Kg/m

Matriz: M2774

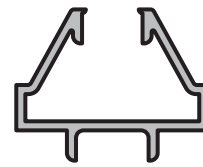
**BASTIDOR VIDRIO REPARTIDO CORREDIZA**

Perfil: 6572

Peso: 0,243 Kg/m

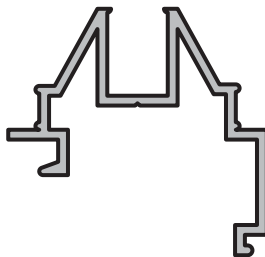
**BASTIDOR VIDRIO REPARTIDO PAÑO FIJO**

Perfil: 802

Peso: 0,389 Kg/m

Matriz: M2776

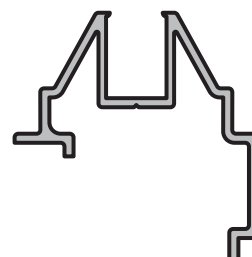
**BASTIDOR VIDRIO REPARTIDO PAÑO FIJO**

Perfil: 6765

Peso: 0,316 Kg/m



TAPA ZOCALO
Perfil: 189
Peso: 0,238 Kg/m
Matriz: M2548

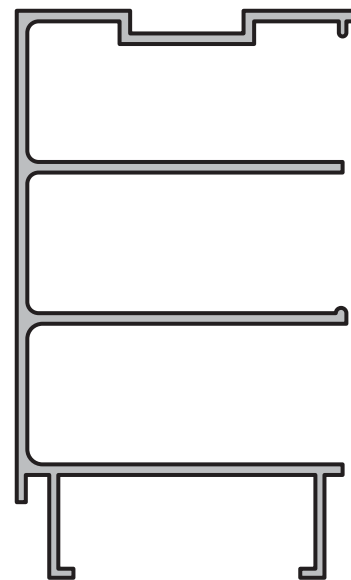

ZOCALO
Perfil: 190
Peso: 1,029 Kg/m
Matriz: M2549

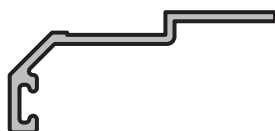

MARCO DE PUERTA
Perfil: 191
Peso: 0,178 Kg/m
Matriz: M2550

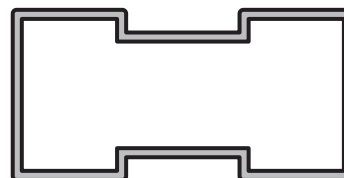

TRAVESAÑO
Perfil: 194
Peso: 0,464 Kg/m
Matriz: M2553



CONTRAVIDRIO LARGO
Perfil: 193
Peso: 0,132 Kg/m
Matriz: M2552

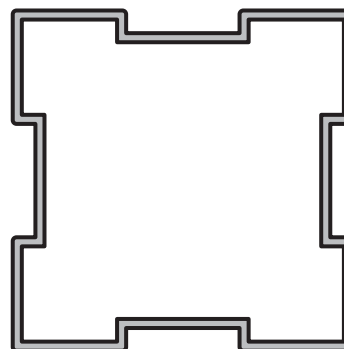

COLUMNA
Perfil: 195
Peso: 0,643 Kg/m
Matriz: M2554



CONTRAVIDRIO CORTO
Perfil: 192
Peso: 0,108 Kg/m
Matriz: M2551

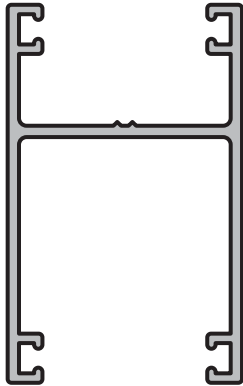

TRAVESAÑO
Perfil: 4361
Peso: 0,620 Kg/m

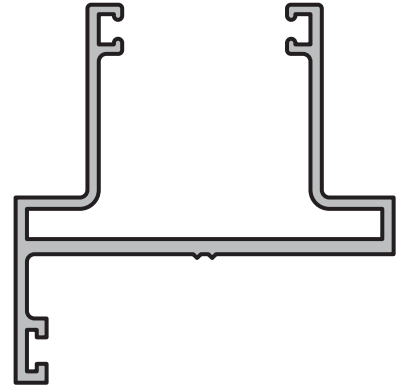

MARCO PUERTA PLACA
Perfil: 4364
Peso: 0,738 Kg/m



TAPA COLUMNA Y TERMINACION PARED
Perfil: 4362
Peso: 0,505 Kg/m

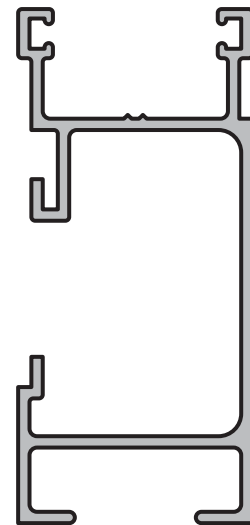

ZOCALO PASACABLE
Perfil: 4365
Peso: 0,832 Kg/m

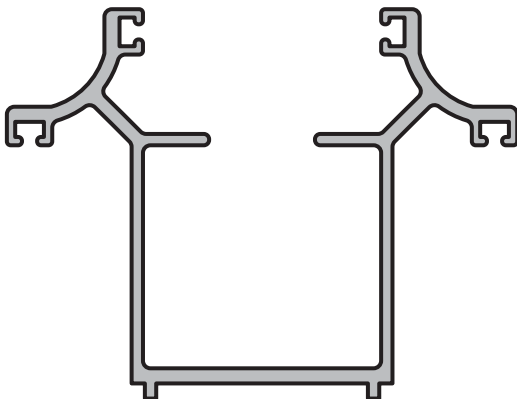

COLUMNA PRINCIPAL
Perfil: 4363
Peso: 0,988 Kg/m



TAPA ZOCALO
Perfil: 4366
Peso: 0,204 Kg/m

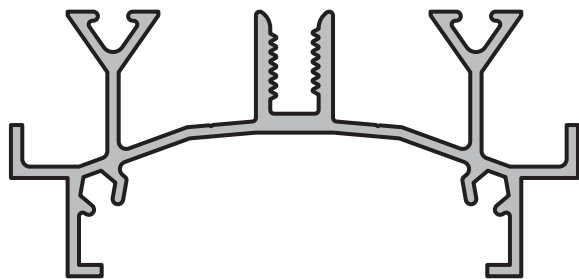

LARGUERO
Perfil: 85
Peso: 1,013 Kg/m
Matriz: M2769



CUBRE TORNILLO
Perfil: 89
Peso: 0,113 Kg/m
Matriz: M2773

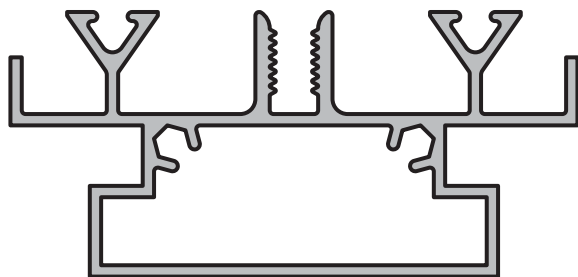

TRAVESAÑO
Perfil: 86
Peso: 1,237 Kg/m
Matriz: M2770



TAPA LARGUERO
Perfil: 87
Peso: 0,486 Kg/m
Matriz: M2771



TAPA TRAVESAÑO
Perfil: 88
Peso: 0,470 Kg/m
Matriz: M2772

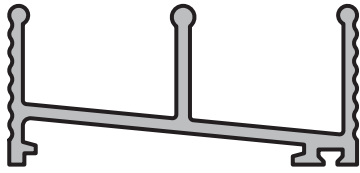

UMBRAL
Perfil: 31
Peso: 0,510 Kg/m
Matriz: M0724

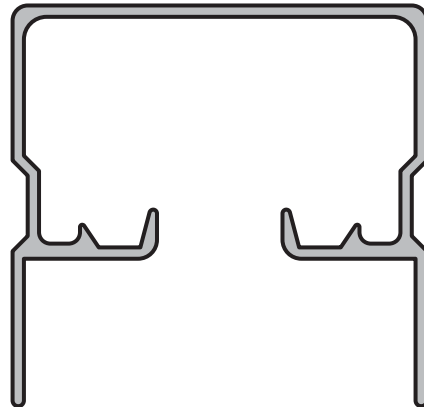

CABEZAL
Perfil: 141
Peso: 0,853 Kg/m
Matriz: M1930

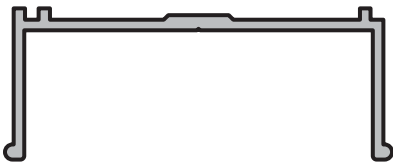

JAMBA
Perfil: 143
Peso: 0,356 Kg/m
Matriz: M1932

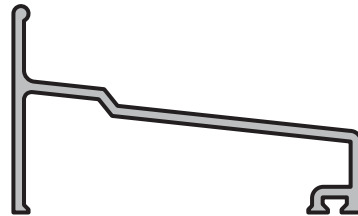

UMBRAL SANITARIO
Perfil: 169
Peso: 0,362 Kg/m
Matriz: M2167

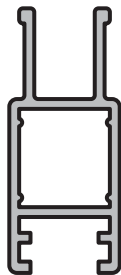

HOJA
Perfil: 144
Peso: 0,362 Kg/m
Matriz: M1933

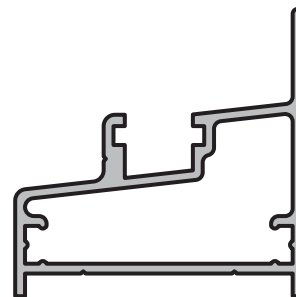

MARCO
Perfil: 188
Peso: 0,545 Kg/m
Matriz: M2463



TOALLERO
Perfil: 147
Peso: 0,273 Kg/m
Matriz: M1984

ABRIL 2001

43

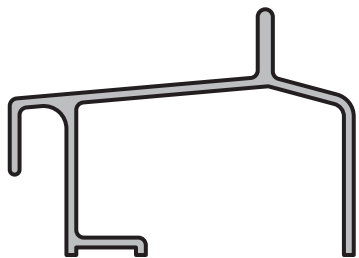

UMBRAL SANITARIO
Perfil: 6926
Peso: 0,419 Kg/m



TRAVESAÑO
Perfil: 6927
Peso: 0,316 Kg/m

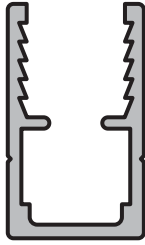

" U " PORTA BLISAN
Perfil: 2441
Peso: 0,491 Kg/m

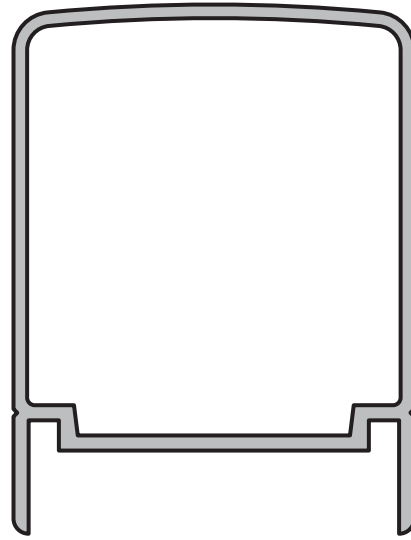

PASAMANOS ALTO
Perfil: 2601
Peso: 1,264 Kg/m



PASAMANOS ALTO BASE
Perfil: 2603
Peso: 0,548 Kg/m



PASAMANOS BAJO
Perfil: 2635
Peso: 0,412 Kg/m

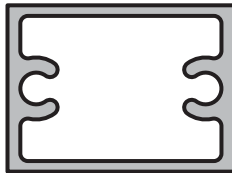

PARANTE ANGOSTO
Perfil: 2633
Peso: 0,510 Kg/m



TAPA DE LARGUERO
Perfil: 2636
Peso: 0,343 Kg/m



PASAMANOS BAJO BASE
Perfil: 2634
Peso: 0,310 Kg/m

ABRIL 2001

45

**PARANTE REFORZADO**

Perfil: 2637

Peso: 0,648 Kg/m

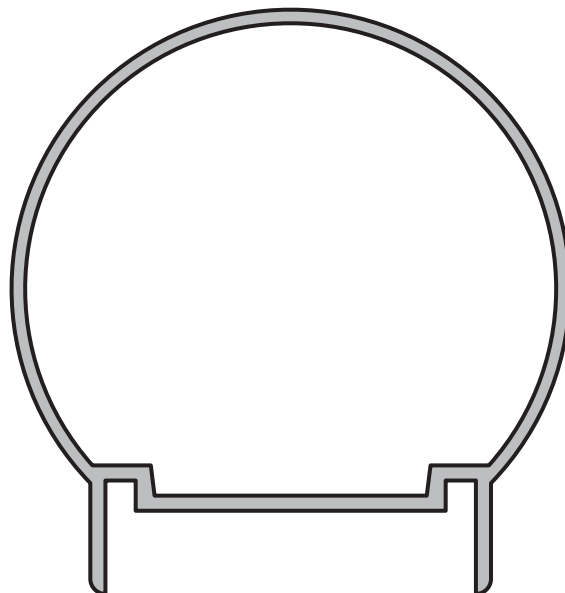
**BARANDA TUBULAR**

Perfil: 6713

Peso: 1,303 Kg/m

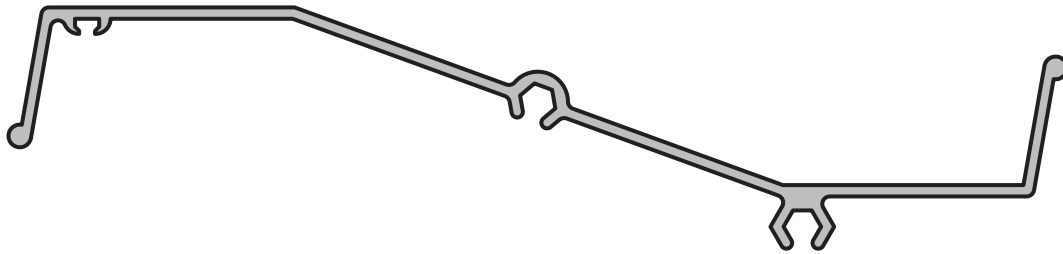

PARASOL MOVIL 140 mm.

Perfil: 36

Peso: 0,832 Kg/m

Matriz: M0729

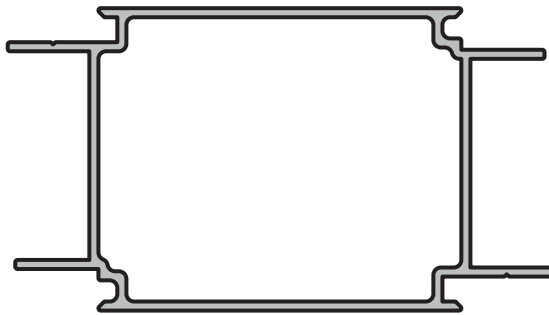

NUCLEO CENTRAL PARASOL

Perfil: 201

Peso: 0,729 Kg/m

Matriz: M2467

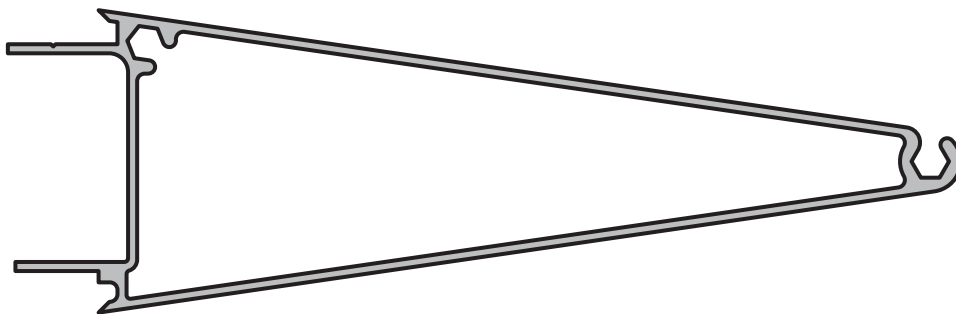

PARASOL MOVIL TUBULAR

Perfil: 202

Peso: 1,048 Kg/m

Matriz: M2533

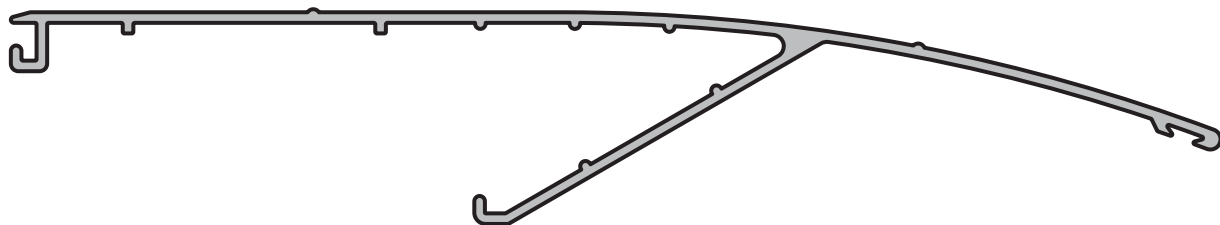

PARASOL MOVIL
Perfil: 5004
Peso: 0,883 Kg/m

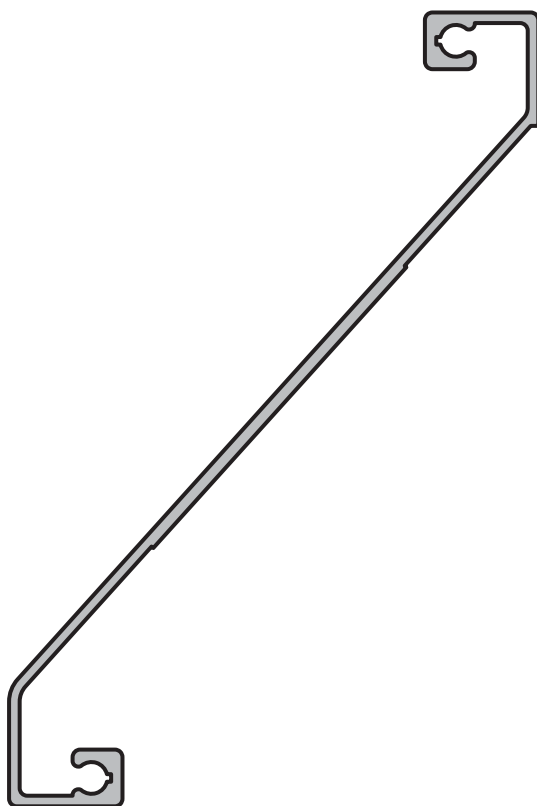

PARASOL DE ALETA FIJA
Perfil: 5650
Peso: 0,780 Kg/m

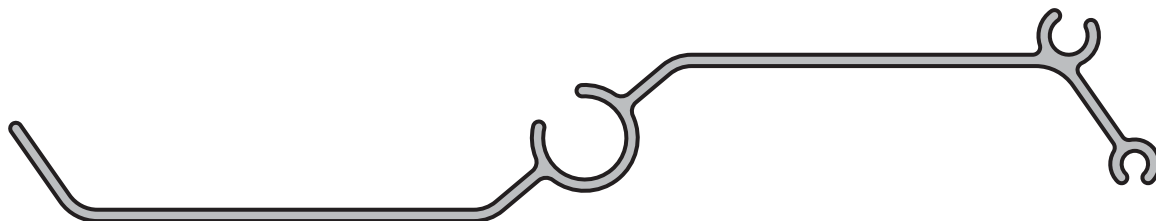

PARASOL MOVIL
Perfil: 5489
Peso: 0,850 Kg/m

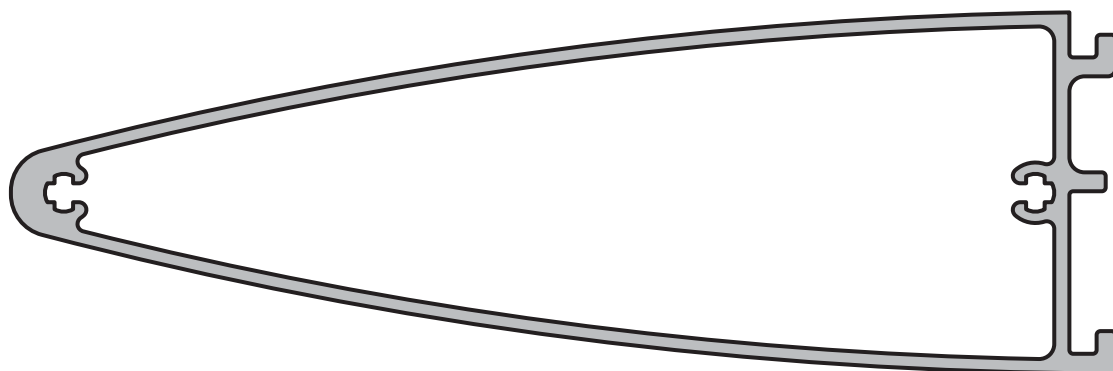

PARASOL PARTE PUNTERA

Perfil: 7257

Peso: 1,968 Kg/m

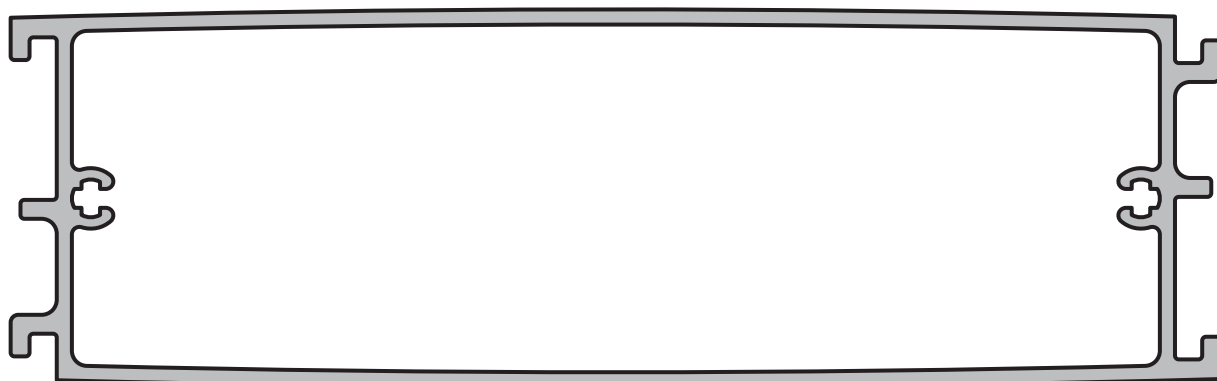

PARASOL PARTE CENTRAL

Perfil: 7259

Peso: 2,525 Kg/m

**PANEL STANDARD LIVIANO**

Perfil: 660

Peso: 0,864 Kg/m

Matriz: M1527

**REVESTIMIENTO PEINE**

Perfil: 683

Peso: 0,710 Kg/m

Matriz: M1696

**REVESTIMIENTO LIVIANO**

Perfil: 688

Peso: 0,340 Kg/m

Matriz: M1803

**REVESTIMIENTO DOBLE FAZ**

Perfil: 5701

Peso: 0,656 Kg/m



REVESTIMIENTO TUBULAR LISO

Perfil: 5726

Peso: 0,907 Kg/m



REVESTIMIENTO TUBULAR 7 mm.

Perfil: 6428

Peso: 0,597 Kg/m



SIMULACION PLACA - BASE

Perfil: 6488

Peso: 0,116 Kg/m



SIMULACION PLACA - TAPA ROMBO

Perfil: 6489

Peso: 0,164 Kg/m

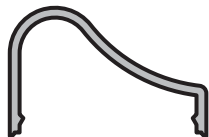

SIMULACION PLACA - TAPA CURVA

Perfil: 6785

Peso: 0,168 Kg/m

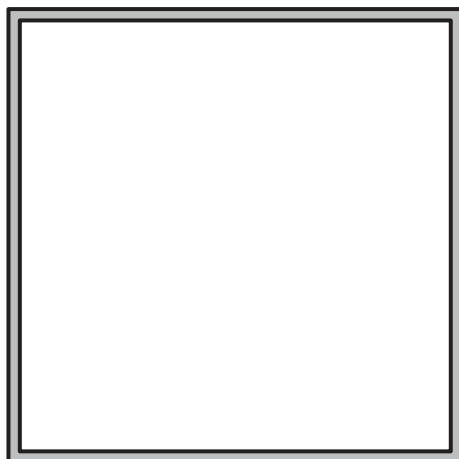

TUBO CUADRADO 60 x 1,5 mm.
Perfil: MC-143
Peso: 0,948 Kg/m



TUBO RECTANGULAR 60 x 25 x 1,5 mm.
Perfil: MC-080
Peso: 0,664 Kg/m

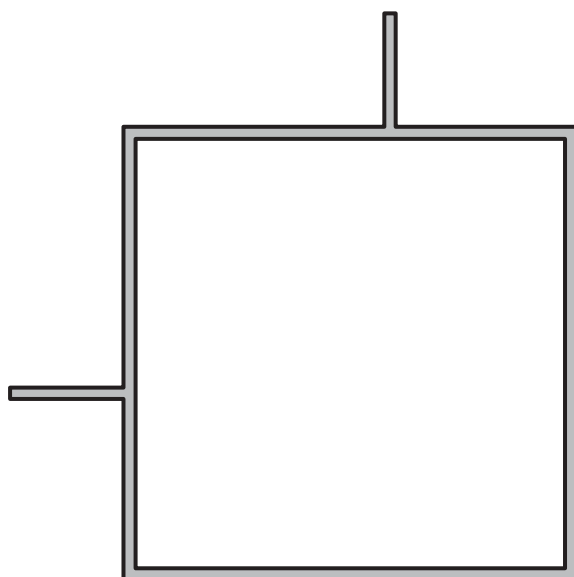

TUBO CUADRADO CON DOS ALETAS DE 60 x 1,6 mm.
Perfil: 2707
Peso: 1,131 Kg/m

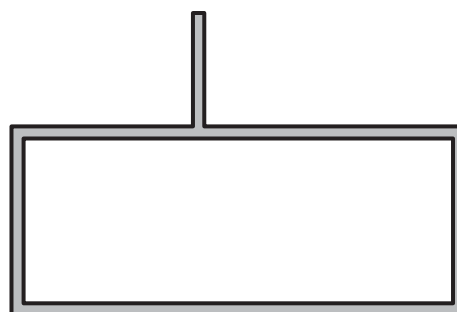

TUBO RECTANGULAR CON UNA ALETA DE 60 x 25 x 1,6 mm.
Perfil: 2674
Peso: 0,770 Kg/m

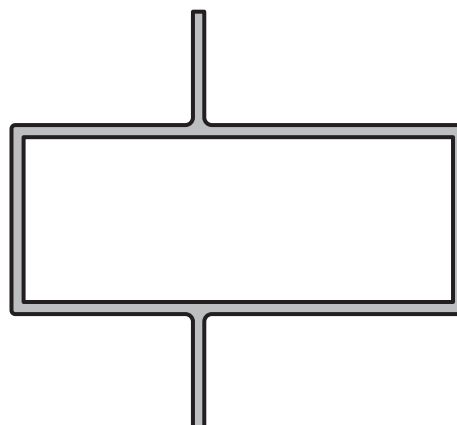

TUBO RECTANGULAR CON DOS ALETAS DE 60 x 25 x 1,6 mm.
Perfil: 3994
Peso: 0,834 Kg/m



CANAL DE 60 x 25 x 1,6 mm.
Perfil: 2610
Peso: 0,535 Kg/m



PORTACONTRAVIDRIO CON ALETA, CLIPA
CON 5588 Y 5596
Perfil: 5753
Peso: 0,175 Kg/m

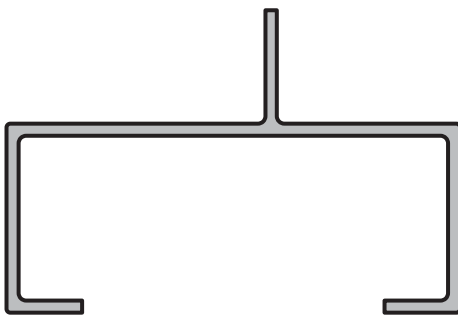

CANAL CON UNA ALETA DE 60 x 25 x 1,6 mm.
Perfil: 3993
Peso: 0,594 Kg/m



PORTACONTRAVIDRIO SIMPLE, CLIPA
CON 5588 Y 5596
Perfil: 5754
Peso: 0,097 Kg/m



PORTACONTRAVIDRIO CON ALETA, CLIPA CON N 8
Perfil: 6924
Peso: 0,186 Kg/m

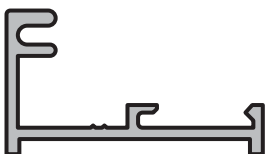

PORTACONTRAVIDRIO UNIVERSAL SIMPLE
Perfil: 52
Peso: 0,300 Kg/m
Matriz: M0947



PORTACONTRAVIDRIO SIMPLE, CLIPA CON N 8
Perfil: 6925
Peso: 0,132 Kg/m

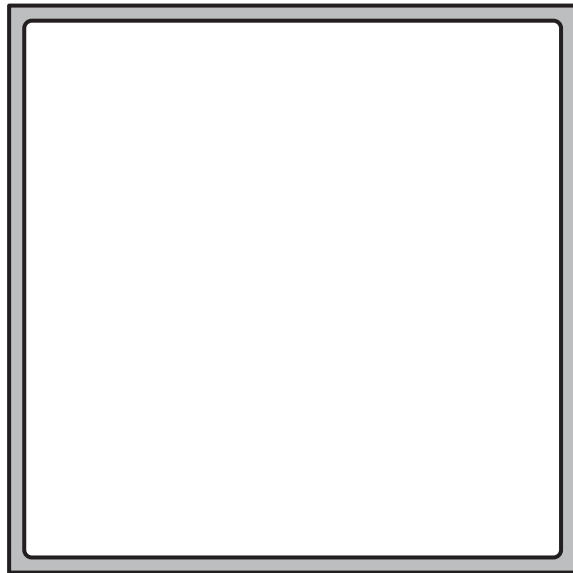

TUBO CUADRADO 75 x 2 mm.

Perfil: 3109

Peso: 1,580 Kg/m

Matriz: PC3109

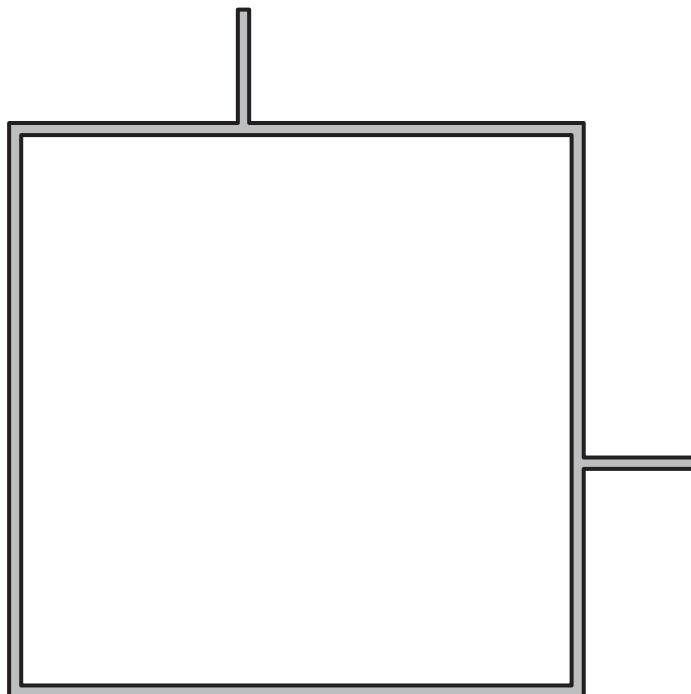

TUBO CUADRADO CON DOS ALETAS DE 76 x 1,6 mm.

Perfil: 2708

Peso: 1,407 Kg/m



TUBO RECTANGULAR 76 x 25 x 1,6 mm.

Perfil: 3988

Peso: 0,845 Kg/m

Matriz: PC3988



CANAL DE 76 x 25 x 1,6 mm.

Perfil: 3992

Peso: 0,605 Kg/m

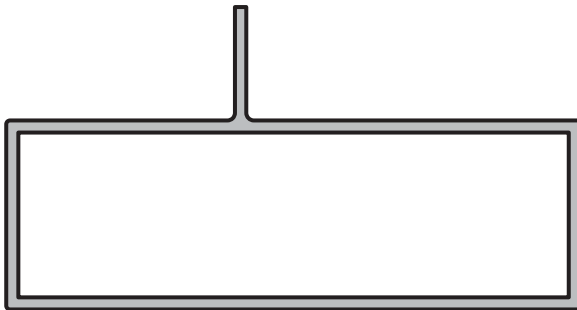

TUBO RECTANGULAR CON UNA ALETA 76 x 25 x 1,6 mm.

Perfil: 3989

Peso: 0,905 Kg/m

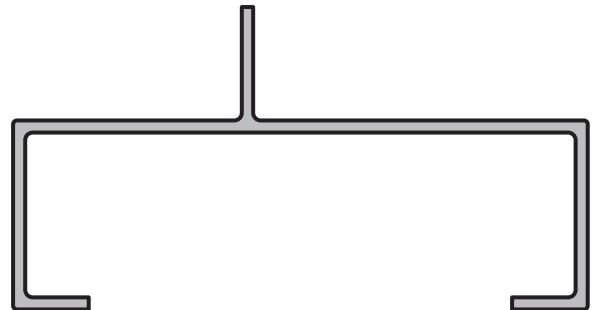

CANAL CON UNA ALETA 76 x 25 x 1,6 mm.

Perfil: 3991

Peso: 0,664 Kg/m

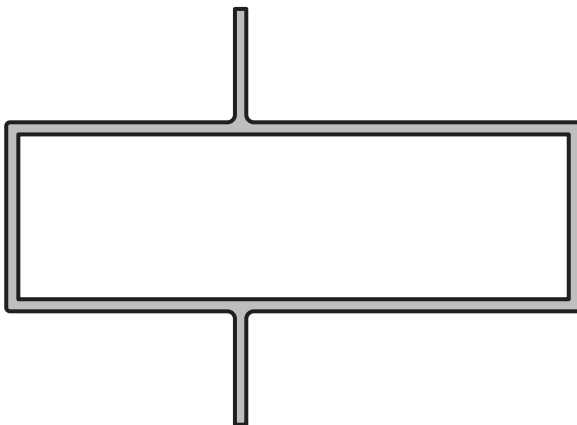

TUBO RECTANGULAR CON DOS ALETAS 76 x 25 x 1,6 mm.

Perfil: 3990

Peso: 0,967 Kg/m

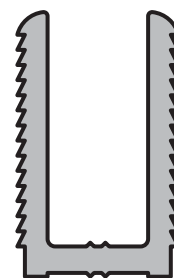

U DE ARMADO SERIES 60 x 25 Y 76 x 25 mm.

Perfil: 3024

Peso: 0,767 Kg/m



TUBO RECTANGULAR 90 x 40 x 2 mm.

Perfil: 4833

Peso: 1,361 Kg/m

Matriz: PC4833

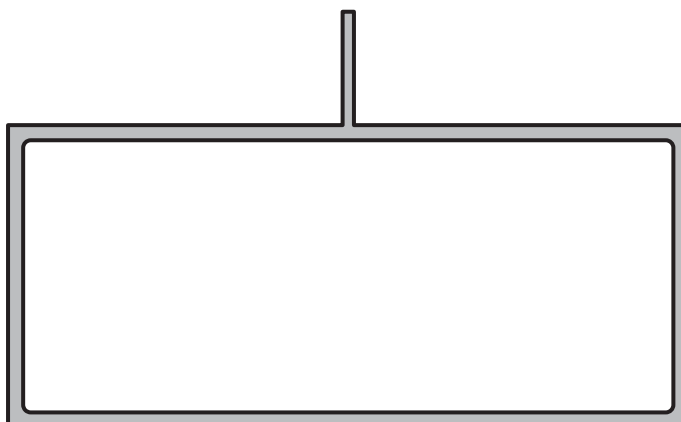

TUBO RECTANGULAR CON UNA ALETA DE 90 x 40 x 2 mm.

Perfil: 5311

Peso: 1,420 Kg/m

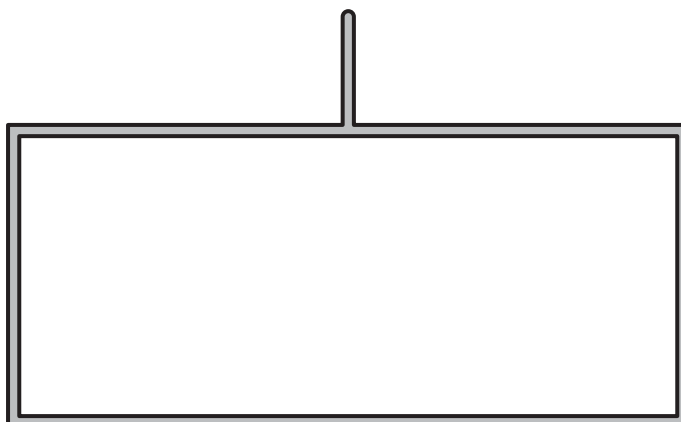

TUBO RECTANGULAR CON UNA ALETA 90 x 40 x 1,5 mm.

Perfil: 492

Peso: 1,080 Kg/m

Matriz: M1980

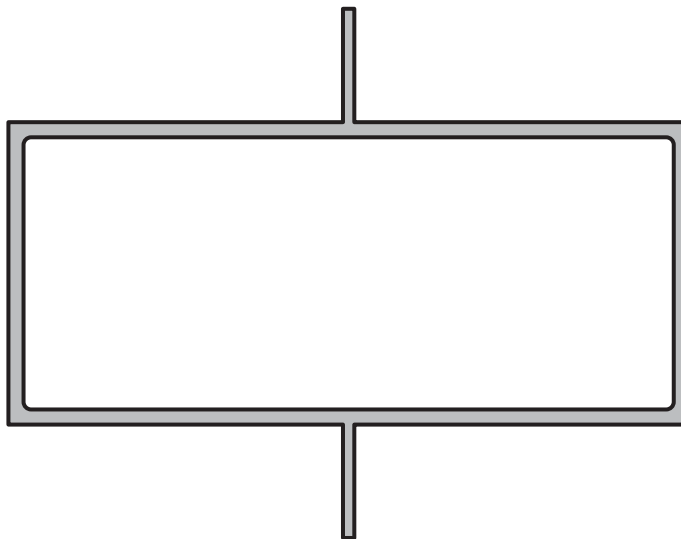

TUBO RECTANGULAR CON DOS ALETAS DE 90 x 40 x 2 mm.

Perfil: 5312

Peso: 1,479 Kg/m

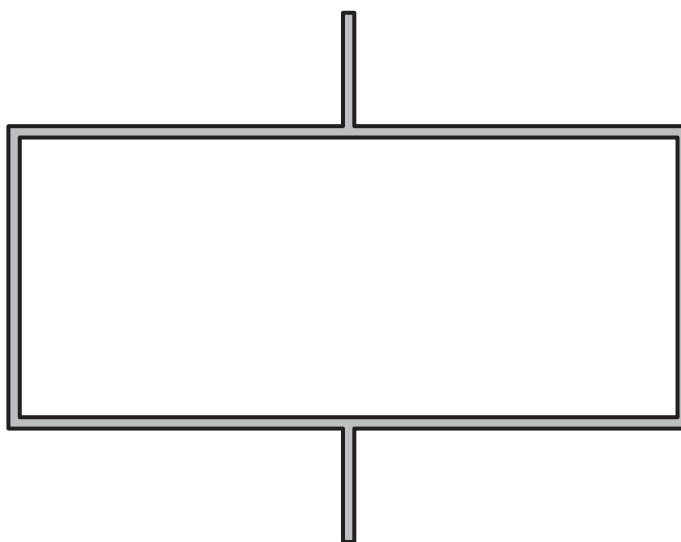

TUBO RECTANGULAR CON DOS ALETAS 90 x 40 x 1,5 mm.

Perfil: 493

Peso: 1,150 Kg/m

Matriz: M1981



CANAL DE 90 x 40 x 2 mm.

Perfil: 4834

Peso: 0,982 Kg/m

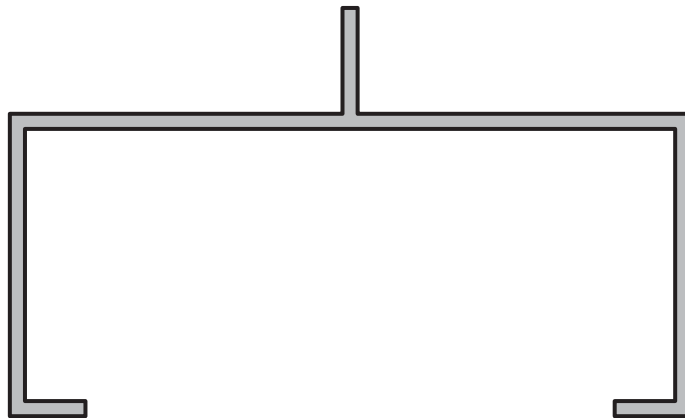

CANAL CON UNA ALETA DE 90 x 40 x 2 mm.

Perfil: 5310

Peso: 1,042 Kg/m



SEMITUBO PARA CUADRADO DE 90 x 90 mm.

Perfil: 2719

Peso: 1,104 Kg/m

ABRIL 2001

58

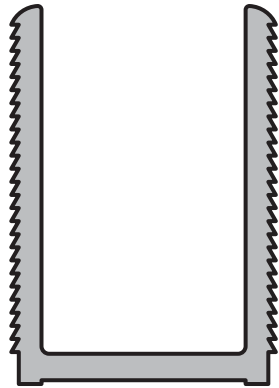

U DE ARMADO SERIE 90 x 40 x 2 mm.

Perfil: 3022

Peso: 1,188 Kg/m

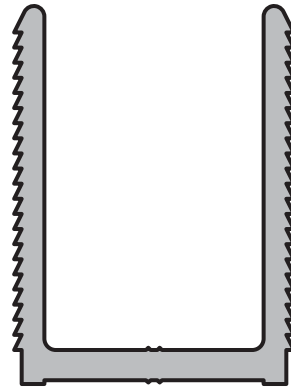

U DE ARMADO SERIE 90 x 40 x 1,5 mm.

Perfil: 494

Peso: 1,237 Kg/m

Matriz: M1982



TUBO RECTANGULAR 100 x 45 x 2 mm.

Perfil: 4836

Peso: 1,523 Kg/m

Matriz: PC4836

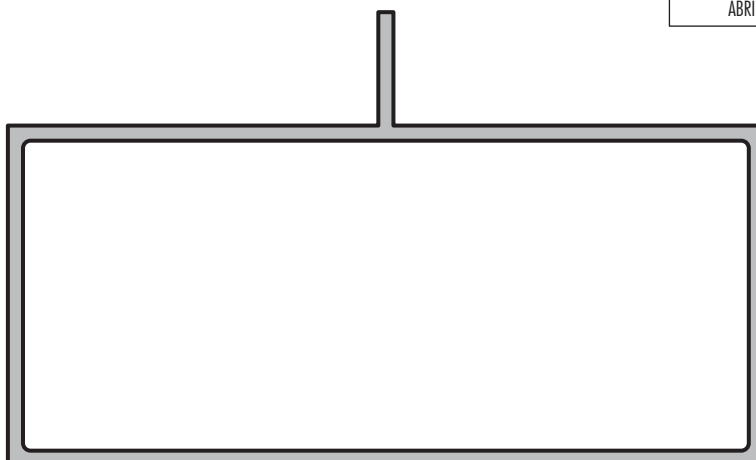

TUBO RECTANGULAR CON UNA ALETA DE 100 x 45 x 2 mm.

Perfil: 5316

Peso: 1,603 Kg/m

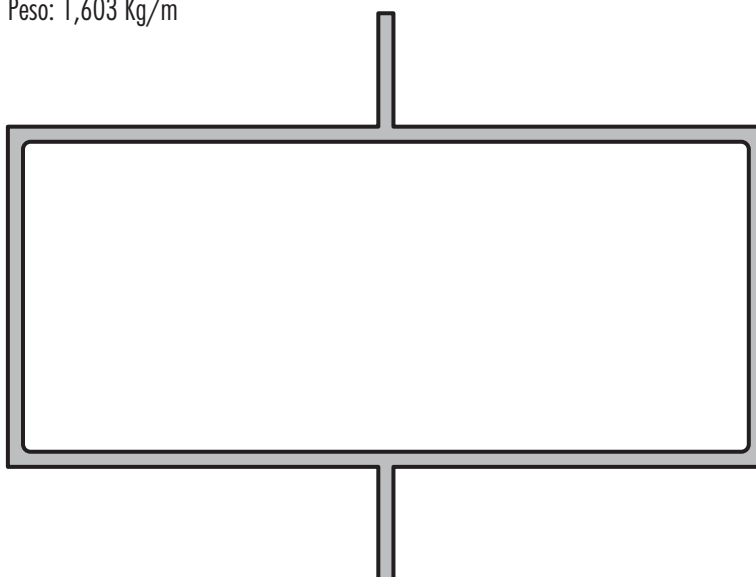

TUBO RECTANGULAR CON DOS ALETAS DE 100 x 45 x 2 mm.

Perfil: 5317

Peso: 1,684 Kg/m

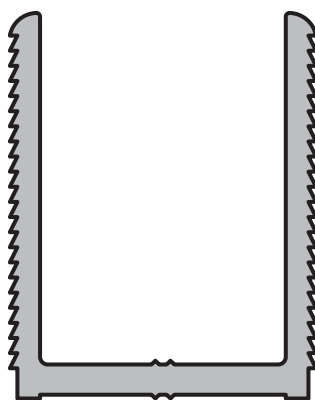

U DE ARMADO SERIE 100x45x2

Perfil: 3046

Peso: 1,258 Kg/m

Prohibida la modificación, publicación o venta; total o parcial de estos documentos, sin la previa autorización por parte de Aluar División Elaborados

Aluar División Elaborados en ningún caso será responsable por los deficientes trabajos ejecutados por terceros en aberturas armadas con nuestros perfiles.
Será de exclusiva responsabilidad del instalador y/o contratista la previa y correcta verificación del cálculo estructural.